

SONY[®]

4-454-443-11(1)

Multi Channel AV Receiver

Operating Instructions

STR-DN1040

WARNING

To reduce the risk of fire or electric shock, do not expose this apparatus to rain or moisture.

To reduce the risk of fire, do not cover the ventilation opening of the appliance with newspapers, tablecloths, curtains, etc. Do not expose the appliance to naked flame sources (for example, lighted candles).

To reduce the risk of fire or electric shock, do not expose this appliance to dripping or splashing, and do not place objects filled with liquids, such as vases, on the appliance.

Do not install the appliance in a confined space, such as a bookcase or built-in cabinet.

As the main plug is used to disconnect the unit from the mains, connect the unit to an easily accessible AC outlet. Should you notice an abnormality in the unit, disconnect the main plug from the AC outlet immediately.

Do not expose batteries or appliances with battery-installed to excessive heat, such as sunshine and fire.

The unit is not disconnected from the mains as long as it is connected to the AC outlet, even if the unit itself has been turned off.

Excessive sound pressure from earphones and headphones can cause hearing loss.



This symbol is intended to alert the user to the presence of the Hot Surface that may be hot if it is touched during the normal operation.

This equipment has been tested and found to comply with the limits set out in the EMC Directive using a connection cable shorter than 3 meters.

For customers in the United States

Owner's Record

The model and serial numbers are located on the rear of the unit. Record these numbers in the space provided below. Refer to them whenever you call upon your Sony dealer regarding this product.

Model No. _____

Serial No. _____



This symbol is intended to alert the user to the presence of uninsulated "dangerous voltage" within the product's enclosure that may be of sufficient magnitude to constitute a risk of electric shock to persons.



This symbol is intended to alert the user to the presence of important operating and maintenance (servicing) instructions in the literature accompanying the appliance.

Important Safety Instructions

- 1) Read these instructions.
- 2) Keep these instructions.
- 3) Heed all warnings.
- 4) Follow all instructions.
- 5) Do not use this apparatus near water.
- 6) Clean only with dry cloth.
- 7) Do not block any ventilation openings. Install in accordance with the manufacturer's instructions.
- 8) Do not install near any heat sources such as radiators, heat registers, stoves, or other apparatus (including amplifiers) that produce heat.

- 9) Do not defeat the safety purpose of the polarized or grounding-type plug. A polarized plug has two blades with one wider than the other. A grounding type plug has two blades and a third grounding prong. The wide blade or the third prong are provided for your safety. If the provided plug does not fit into your outlet, consult an electrician for replacement of the obsolete outlet.
- 10) Protect the power cord from being walked on or pinched particularly at plugs, convenience receptacles, and the point where they exit from the apparatus.
- 11) Only use attachments/accessories specified by the manufacturer.
- 12) Use only with the cart, stand, tripod, bracket, or table specified by the manufacturer, or sold with the apparatus. When a cart is used, use caution when moving the cart/apparatus combination to avoid injury from tip-over.



- 13) Unplug this apparatus during lightning storms or when unused for long periods of time.
- 14) Refer all servicing to qualified service personnel. Servicing is required when the apparatus has been damaged in any way, such as power-supply cord or plug is damaged, liquid has been spilled or objects have fallen into the apparatus, the apparatus has been exposed to rain or moisture, does not operate normally, or has been dropped.

To reduce the risk of electric shock, the speaker cord should be connected to the apparatus and the speakers in accordance with the following instructions.

- 1) Disconnect the AC power cord from the MAINS.
- 2) Strip 10 to 15 mm of the wire insulation of the speaker cord.

- 3) Connect the speaker cord to the apparatus and the speakers carefully so as not to touch the core of speaker cord by hand. Also disconnect the AC power cord from the MAINS before disconnecting the speaker cord from the apparatus and the speakers.

The following FCC statement applies only to the version of this model manufactured for sale in the U.S.A. Other versions may not comply with FCC technical regulations.

NOTE:

This equipment has been tested and found to comply with the limits for a Class B digital device, pursuant to Part 15 of the FCC Rules. These limits are designed to provide reasonable protection against harmful interference in a residential installation. This equipment generates, uses and can radiate radio frequency energy and, if not installed and used in accordance with the instructions, may cause harmful interference to radio communications. However, there is no guarantee that interference will not occur in a particular installation. If this equipment does cause harmful interference to radio or television reception, which can be determined by turning the equipment off and on, the user is encouraged to try to correct the interference by one or more of the following measures:

- Reorient or relocate the receiving antenna.
- Increase the separation between the equipment and receiver.
- Connect the equipment into an outlet on a circuit different from that to which the receiver is connected.
- Consult the dealer or an experienced radio/TV technician for help.

CAUTION

You are cautioned that any changes or modifications not expressly approved in this manual could void your authority to operate this equipment.

Properly shielded and grounded cables and connectors must be used for connection to host computers and/or peripherals in order to meet FCC emission limits.

This equipment must not be co-located or operated in conjunction with any other antenna or transmitter.

This equipment complies with FCC radiation exposure limits set forth for an uncontrolled environment and meets the FCC radio frequency (RF) Exposure Guidelines in Supplement C to OET65.

This equipment should be installed and operated keeping the radiator at least 20cm or more away from person's body (excluding extremities: hands, wrists, feet and ankles).

For customers in Canada

Properly shielded and grounded cables and connectors must be used for connection to host computers and/or peripherals.

Operation is subject to the following two conditions:

- (1) this device may not cause interference, and
- (2) this device must accept any interference, including interference that may cause undesired operation of the device.

This equipment complies with IC radiation exposure limits set forth for an uncontrolled environment and meets RSS-102 of the IC radio frequency (RF) Exposure rules.

This equipment should be installed and operated keeping the radiator at least 20cm or more away from person's body (excluding extremities: hands, wrists, feet and ankles).

About This Manual

- The instructions in this manual are for model STR-DNI040. The model number is located at the lower right corner of the front panel. The illustrations used in this manual are of the USA model and they may be different from your model. Any differences in operation are marked in the manual as "USA model only".
- The instructions in this manual describe the operation of the receiver with the supplied remote control. You can also use the buttons or knobs on the receiver if they have the same or similar names as those on the remote control.

On copyrights

This receiver incorporates Dolby* Digital and Pro Logic Surround and the DTS** Digital Surround System.

* Manufactured under license from Dolby Laboratories. Dolby, Pro Logic, Surround EX, and the double-D symbol are trademarks of Dolby Laboratories.

** Manufactured under license under U.S. Patent Nos: 5,956,674; 5,974,380; 6,226,616; 6,487,535; 7,212,872; 7,333,929; 7,392,195; 7,272,567 & other U.S. and worldwide patents issued & pending. DTS-HD, the Symbol, & DTS-HD and the Symbol together are registered trademarks & DTS-HD Master Audio is a trademark of DTS, Inc. Product includes software. © DTS, Inc. All Rights Reserved.

This receiver incorporates High-Definition Multimedia Interface (HDMI™) technology. The terms HDMI and HDMI High-Definition Multimedia Interface, and the HDMI Logo are trademarks or registered trademarks of HDMI Licensing LLC in the United States and other countries.

AirPlay, iPhone, iPod, iPod classic, iPod nano, and iPod touch are trademarks of Apple Inc., registered in the U.S. and other countries.

All other trademarks and registered trademarks are of their respective holders. In this manual, ™ and ® marks are not specified.

“Made for iPod” and “Made for iPhone” mean that an electronic accessory has been designed to connect specifically to iPod or iPhone, respectively, and has been certified by the developer to meet Apple performance standards.

Apple is not responsible for the operation of this device or its compliance with safety and regulatory standards. Please note that the use of this accessory with iPod or iPhone may affect wireless performance.

DLNA™, the DLNA Logo and DLNA CERTIFIED™ are trademarks, service marks, or certification marks of the Digital Living Network Alliance.

“Sony Entertainment Network” logo and “Sony Entertainment Network” are trademarks of Sony Corporation.

Wake-on-LAN is a trademark of International Business Machines Corporation in the United States.

Windows and the Windows logo are either registered trademarks or trademarks of Microsoft Corporation in the United States and/or other countries.

This product is protected by certain intellectual property rights of Microsoft Corporation. Use or distribution of such technology outside of this product is prohibited without a license from Microsoft or an authorized Microsoft subsidiary.

MPEG Layer-3 audio coding technology and patents licensed from Fraunhofer IIS and Thomson.

“x.v.Color (x.v.Colour)” and “x.v.Color (x.v.Colour)” logo are trademarks of Sony Corporation.

“BRAVIA” is a trademark of Sony Corporation.

“PlayStation” is a registered trademark of Sony Computer Entertainment Inc.

“WALKMAN” and “WALKMAN” logo are registered trademarks of Sony Corporation.

MICROVAULT is a trademark of Sony Corporation.

VAIO and VAIO Media are registered trademarks of Sony Corporation.

PARTY STREAMING and PARTY STREAMING logo are trademarks of Sony Corporation.

The Wi-Fi CERTIFIED Logo is a certification mark of the Wi-Fi Alliance.

MHL, Mobile High-Definition Link and the MHL Logo are trademarks or registered trademarks of MHL Licensing, LLC.

InstaPrevue™ is a trademark or registered trademark of Silicon Image, Inc. in the United States and other countries.

The *Bluetooth*® word mark and logos are registered trademarks owned by Bluetooth SIG, Inc. and any use of such marks by Sony Corporation is under license.

Other trademarks and trade names are those of their respective owners.

FLAC Decoder

Copyright (C)

2000,2001,2002,2003,2004,2005,2006,2007

Josh Coalson

Redistribution and use in source and binary forms, with or without modification, are permitted provided that the following conditions are met:

- Redistributions of source code must retain the above copyright notice, this list of conditions and the following disclaimer.
- Redistributions in binary form must reproduce the above copyright notice, this list of conditions and the following disclaimer in the documentation and/or other materials provided with the distribution.
- Neither the name of the Xiph.org Foundation nor the names of its contributors may be used to endorse or promote products derived from this software without specific prior written permission.

THIS SOFTWARE IS PROVIDED BY THE COPYRIGHT HOLDERS AND CONTRIBUTORS "AS IS" AND ANY EXPRESS OR IMPLIED WARRANTIES, INCLUDING, BUT NOT LIMITED TO, THE IMPLIED WARRANTIES OF MERCHANTABILITY AND FITNESS FOR A PARTICULAR PURPOSE ARE DISCLAIMED. IN NO EVENT SHALL THE FOUNDATION OR CONTRIBUTORS BE LIABLE FOR ANY DIRECT, INDIRECT, INCIDENTAL, SPECIAL, EXEMPLARY, OR CONSEQUENTIAL DAMAGES (INCLUDING, BUT NOT LIMITED TO, PROCUREMENT OF SUBSTITUTE GOODS OR SERVICES; LOSS OF USE, DATA, OR PROFITS; OR BUSINESS INTERRUPTION) HOWEVER CAUSED AND ON ANY THEORY OF LIABILITY, WHETHER IN CONTRACT, STRICT LIABILITY, OR TORT (INCLUDING NEGLIGENCE OR OTHERWISE) ARISING IN ANY WAY OUT OF THE USE OF THIS SOFTWARE, EVEN IF ADVISED

OF THE POSSIBILITY OF SUCH DAMAGE.

Table of Contents

About This Manual	4
Supplied accessories	9
Description and location of parts	10
Getting started	21

Connections

1: Installing the speakers	24
2: Connecting the speakers	26
3: Connecting the TV	28
4: Connecting other equipment	29
5: Connecting the antennas (aerials)	34
6: Connecting to the network	35

Preparing the Receiver

Setting the voltage selector	37
Connecting the AC power cord (mains lead)	37
Turning on the receiver	37
Setting up the receiver using the Easy Setup	37
Configuring the network settings of the receiver	39
Guide to on-screen display operation	43

Basic Operations

Enjoying images/sound from the connected equipment	45
Playing an iPod/iPhone	47
Playing a USB device	49

Tuner Operations

Listening to FM/AM radio	52
Presetting FM/AM radio stations (Preset Memory)	54

Enjoying Sound Effects

Selecting the sound field	55
Adjusting the equalizer	58
Using the Sound Optimizer function	59
Selecting the calibration type	59
Using the Pure Direct function	59
Resetting sound fields to the default settings	60

Using Network Features

About the network functions of the receiver	60
Setting up the server	61
Enjoying audio content stored on the server	66
Enjoying Sony Entertainment Network (SEN)	70
Using the PARTY STREAMING function	72
Streaming music from iTunes with AirPlay	73
Updating the software	75
Searching for an item using a keyword	77

Using Bluetooth Features

About the <i>Bluetooth</i> wireless technology	78
---	----

“BRAVIA” Sync Features

What is “BRAVIA” Sync?	82
Preparing for the “BRAVIA” Sync	82
One-Touch Play	83
System Audio Control	83
System Power-Off	83
Scene Select	84
Home Theatre Control	84
Remote Easy Control	84
Controlling the MHL device	85
Switching the monitors that output the HDMI video signals	85

Other Operations

Switching between digital and analog audio (INPUT MODE)	86
Using other video/audio input jacks (Input Assign)	86
Using a bi-amplifier connection	87
Using multi-zone features	88
Reverting back to the factory default settings	90

Adjusting Settings

Using the Settings menu	90
Easy Setup	93
Speaker Settings menu	93
Audio Settings menu	97
HDMI Settings menu	99
Input Settings menu	100
Network Settings menu	101
System Settings menu	102
Operating without using the GUI	102

Using the Remote Control

Programming the remote control	108
Resetting the remote control	112

Additional Information

Precautions	113
Troubleshooting	115
Specifications	127
Index	131

Supplied accessories

- Operating Instructions (this manual)
- Quick Setup Guide (1)
- Remote control (RM-AAP102) (1)
- R6 (size AA) batteries (2)
- FM wire antenna (aerial) (1)



- AM loop antenna (aerial) (1)



- Optimizer microphone (ECM-AC2) (1)



Inserting batteries into the remote control

Insert two R6 (size-AA) batteries (supplied) in the remote control. Observe the correct polarity when installing batteries.

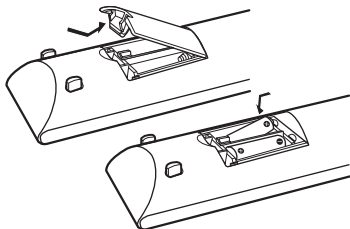

Notes

- Do not leave the remote control in an extremely hot or humid place.
- Do not use a new battery with old ones.
- Do not mix manganese batteries and other kinds of batteries.
- Do not expose the remote control sensor to direct sunlight or lighting apparatuses. Doing so may cause a malfunction.
- If you do not intend to use the remote control for an extended period of time, remove the batteries to avoid possible damage from battery leakage and corrosion.
- When you replace or remove the batteries, the programmed codes may be cleared. If this happens, reprogram the remote control (page 108).
- When the receiver no longer responds to the remote control, replace all the batteries with new ones.

Description and location of parts

Front panel

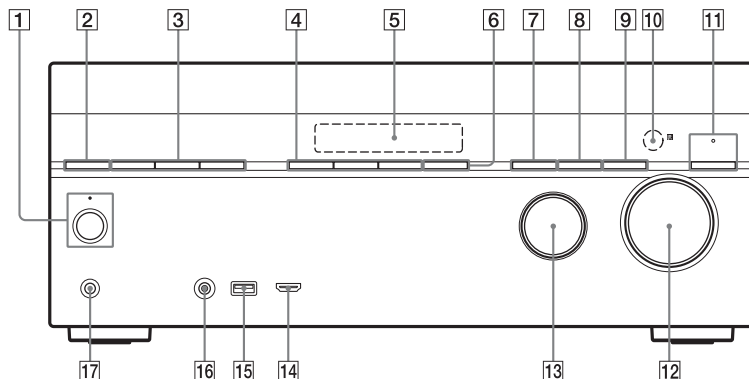

1 I/⏻ (on/standby) (page 37, 53, 60, 90)

The indicator above the button lights up as follows:

Green: The receiver is turned on.
Amber: The receiver is in standby mode, and

– Either “Control for HDMI” (page 99), “Network Standby” (page 101), or “Bluetooth Standby” (page 81) is set to “On”.

– “Pass Through” is set to “On” or “Auto” (page 99).

– The receiver in zone 2 is turned on (page 89).

Lights off when the receiver is in standby mode and “Control for HDMI”, “Pass Through”, “Network Standby”, and “Bluetooth Standby” are set to “Off”.

Note

If the indicator flashes slowly, the software update is in progress (page 75).

2 SPEAKERS (page 39)

3 TUNING MODE, TUNING +/-

Press TUNING MODE to operate a tuner (FM/AM).

Press TUNING +/- to scan a station.

4 A.F.D./2CH, MOVIE, MUSIC (page 46, 55, 60)

5 Display panel (page 12)

6 SOUND OPTIMIZER (page 59)

7 BLUETOOTH (page 78)

Operates the *Bluetooth* function.

8 DIMMER

Adjusts the brightness of the display panel in 3 levels.

9 DISPLAY (page 107)

10 Remote control sensor

Receives signals from remote control.

11 PURE DIRECT (page 59)

The indicator above the button lights up when Pure Direct function is activated.

12 MASTER VOLUME (page 46, 97)

13 INPUT SELECTOR (page 39, 46, 86)

14 HDMI/MHL (VIDEO 2 IN) jack
(page 32)

15 Ψ (USB) port (page 34)

16 AUTO CAL MIC jack

17 PHONES jack

Connects to headphones.

Indicators on the display panel

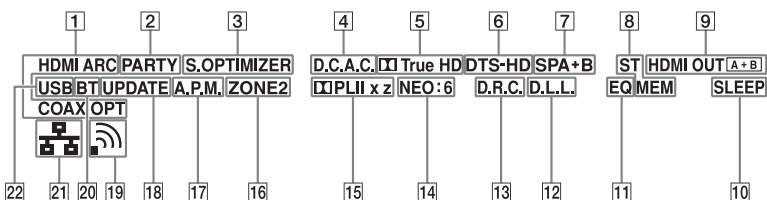

1 Input indicator

Lights up to indicate the current input.

HDMI

The receiver recognizes the equipment connected via an HDMI IN jack.

ARC

TV input is selected and the Audio Return Channel (ARC) signals are detected.

COAX

Digital signal is input through the COAXIAL jack (page 86).

OPT

Digital signal is input through the OPTICAL jack (page 86).

2 PARTY

Lights up when PARTY STREAMING function is activated (page 72).

3 S.OPTIMIZER

Lights up when Sound Optimizer function is activated (page 59).

4 D.C.A.C.

Lights up when the measurement results of the “Auto Calibration” function are applied.

5 Dolby Digital Surround indicator*

Lights up the respective indicator when the receiver is decoding the corresponding Dolby Digital format signals.

 Dolby Digital
 TrueHD Dolby TrueHD

6 DTS(-HD) indicator*

Lights up the respective indicator when the receiver is decoding the corresponding DTS format signals.

DTS DTS

DTS-HD DTS-HD

7 Speaker system indicator (page 39)

8 Tuning indicator

ST

Lights up when the receiver tunes to a stereo broadcast.

MEM

Lights up when memory function, such as Preset Memory (page 54), etc., is activated.

9 HDMI OUT A + B (page 85)

10 SLEEP

Lights up when the Sleep Timer is activated (page 16).

11 EQ

Lights up when the equalizer is activated.

12 D.L.L.

Lights up when the Digital Legato Linear (D.L.L.) function is activated (page 97).

13 D.R.C.





Lights up when dynamic range compression is activated (page 99).

14 NEO:6

Lights up when DTS Neo:6 Cinema/Music decoding is activated (page 56, 57).

15 Dolby Pro Logic indicator

Lights up the respective indicator when the receiver performs Dolby Pro Logic processing. This matrix surround decoding technology can enhance input signals.

	PL	Dolby Pro Logic
	PLII	Dolby Pro Logic II
	PLIIX	Dolby Pro Logic Ix
	PLIIZ	Dolby Pro Logic Iiz

Note

These indicators may not light up depending on the speaker pattern setting.

16 ZONE 2

Lights up while operation in zone 2 is being enabled.

17 A.P.M.



Lights up when the A.P.M. (Automatic Phase Matching) function is activated. You can only set the A.P.M. function in the DCAC (Digital Cinema Auto Calibration) function (page 95).

18 UPDATE

Lights up when a new software is available (page 75).

19 Wireless LAN signal strength indicator

Lights up to show the strength of the wireless LAN signal (page 41, 42).

- No signal.
-  The signal strength is weak.
-  The signal strength is moderate.
-  The signal strength is strong.

20 BT

Lights up when *Bluetooth* device is connected (page 80).

21 Wired LAN indicator

Lights up when LAN cable is connected.

22 USB

Lights up when iPod/iPhone or USB device is detected.

* When playing a Dolby Digital or DTS format disc, make sure that you have completed the digital connections and that INPUT MODE is not set to "ANALOG" (page 86) or "2ch Analog Direct" is not selected.

Rear panel

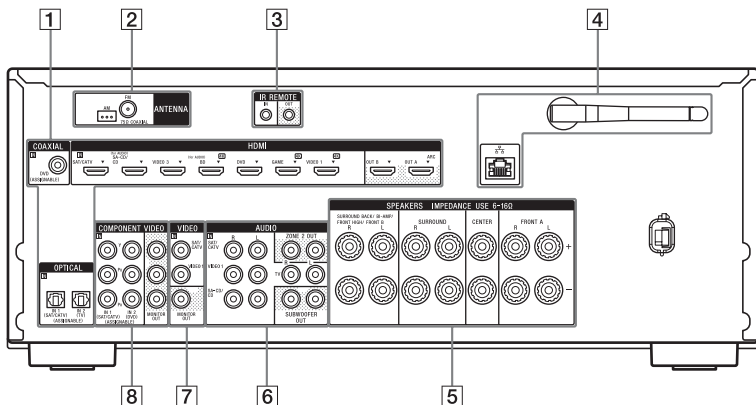

1 DIGITAL INPUT/OUTPUT section

 HDMI IN/OUT* jacks (page 28, 31)

 OPTICAL IN jacks (page 28, 33)

 COAXIAL IN jack (page 33)

2 TUNER section

 FM ANTENNA jack (page 34)

 AM ANTENNA terminals (page 34)

3 Controls jacks for Sony equipment and other external equipment

 IR REMOTE IN/OUT jacks (page 88)

4 NETWORK section

 LAN port** (page 36)

 Wireless LAN antenna (page 36)

5 SPEAKERS section (page 26)

 +
 -

6 AUDIO INPUT/OUTPUT section

 White (L) AUDIO IN jacks (page 33)

 Red (R)

 Black SUBWOOFER OUT jacks (page 26)

 ZONE 2 OUT jacks (page 88)

7 VIDEO INPUT/OUTPUT section (page 28, 33)

 Yellow VIDEO IN/OUT* jacks

8 COMPONENT VIDEO INPUT/ OUTPUT section (page 28, 33)

- ① Green (Y)
- ② Blue (PB) Y, PB, PR IN/OUT* jacks
- ③ Red (PR)

* You must connect the HDMI OUT or MONITOR OUT jack to your TV to watch the selected input image (page 28).

** You can also use this port for maintenance and service (page 101).

Remote control

Use the supplied remote control to operate this receiver and other equipment. The remote control is pre-programmed to operate Sony audio/video equipment. You can also program the remote control to operate non-Sony equipment. For details, see "Programming the remote control" (page 108).

RM-AAP102

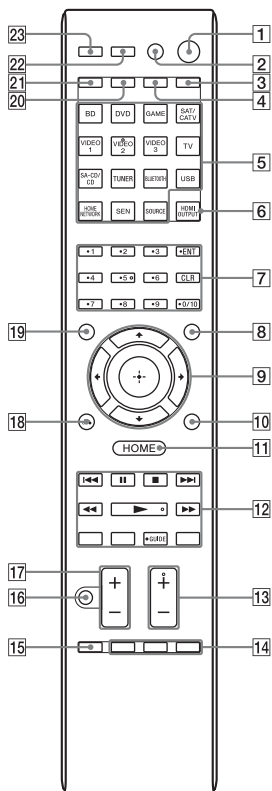

1 I/⏻ (on/standby)

Turns the receiver on or sets it to the standby mode.

If you press ZONE (20) to switch the remote control to zone 2 mode, you can turn the power for zone 2 on or off using I/⏻ (page 89).

Saving the power in standby mode

When “Control for HDMI”, “Pass Through”, “Network Standby”, and “Bluetooth Standby” are set to “Off”, and the receiver in zone 2 is turned off.

2 AV I/⏻¹⁾ (on/standby)

Turns on or off the audio/video equipment that the remote control is programmed to operate.

To turn the TV on or off, press TV (21) and then press AV I/⏻.

Note

The function of the AV I/⏻ changes automatically each time you press the input buttons (5).

3 SLEEP

Press AMP (4), then press SLEEP to set the receiver to turn off automatically at specified time.

Each time you press SLEEP, the display changes cyclically as follows:

0:30:00 → 1:00:00 → 1:30:00 →
2:00:00 → OFF

Tips

- To check the remaining time before the receiver turns off, press SLEEP. The remaining time appears on the display panel.
- The Sleep Timer will be canceled when you perform the following.
 - Press SLEEP again.
 - Update the software of the receiver.
 - Press I/⏻.

TV INPUT

Press TV (21), then press TV INPUT to select the input signal (TV input or video input).

4 AMP

Activates the receiver operation for main zone (page 107).

5 Input buttons²⁾

Selects the equipment you want to use. When you press any of the input buttons, the receiver turns on. The input buttons are pre-assigned to automatically control Sony equipment when you select them. You can also program the remote control to control non-Sony equipment following the steps in “Programming the remote control” on page 108.

6 HDMI OUTPUT (page 85)

7 Numeric/text buttons¹⁾²⁾

Press to

- preset/tune to the preset stations (page 54).
- select track numbers. Press 0/10 to select track number 10.
- select channel numbers.
- select the letters (ABC, DEF, etc.).
- select @ for the punctuation marks (!, ?, etc.) or other symbols (#, %, etc.) when you enter characters for network features.

Press TV (21), then press the numeric buttons to select the TV channels.

ENT¹⁾

Enters the value after selecting a channel, disc, or track using numeric buttons.

CHARACTER

Selects the character type for network features.

Each time you press CHARACTER, the character type changes in sequence as follows:

“abc” (lowercase letters) → “ABC” (uppercase letters) → “123” (numbers)

CLR¹⁾

Press to

- erase a letter for network features.
- clear a mistake when you press the incorrect numeric/text button.

-/--¹⁾

Selects channel entry mode, either one or two digit.

Press TV (21), then press -/-- to select the TV channel entry mode.

>10¹⁾

Selects track numbers over 10.

INPUT MODE (page 86)

8 AMP MENU

Displays the menu to operate the receiver (page 102).

9 ⊕¹⁾, ▲/▼/◀/▶¹⁾

Press ▲/▼/◀/▶ to select the menu items, then press ⊕ to enter/confirm the selection.

10 OPTIONS¹⁾

Displays and selects items from the options menus.

Press TV (21), then press OPTIONS to display the TV function options.

11 HOME¹⁾

Displays the menu of the audio/video equipment that is currently being controlled by the remote control.

For example, press AMP (4), then press HOME to display the home menu (page 44).

Press the input buttons (5), then press HOME to display the menu of the equipment that you want to control.

12 ◀◀/▶▶¹⁾, ◀◀/▶▶¹⁾, ▶▶¹⁾²⁾, ■■¹⁾, ■¹⁾

Skip, backward/forward, play, pause, stop operation.

PRESET +/-¹⁾

Selects preset stations or channels.

TUNING +/-

Scans a station.

D.TUNING²⁾

Enters direct tuning mode.

PARTY START/CLOSE

Starts or closes a PARTY (page 72).

PARTY JOIN/LEAVE

Joins or leaves a PARTY (page 73).

GUIDE¹⁾

Press TV (21), then press GUIDE to display the on-screen program guide.

REPEAT¹⁾

Plays a track or a folder repeatedly.

SHUFFLE¹⁾

Plays a track or a folder in random order.

13 TV CH +/-¹⁾²⁾

Press TV (21), then press TV CH +/- to scan for the preset TV channels.

SOUND FIELD +/-²⁾

Selects a sound field (page 55).

14 ALPHABET SEARCH

Searches for an item using a keyword (page 77).

ALPHABET PREVIOUS

Searches for previous item.

ALPHABET NEXT

Searches for next item.

PREVIEW (HDMI)

Selects the "Preview for HDMI" function.

Turns on a live picture-in-picture preview of HDMI inputs connected to this receiver.

Press ▲/▼ repeatedly to select each HDMI input preview, then press ⊕ to enter/confirm the selection.

(This feature is powered by Silicon Image InstaPrevue™ technology)

Note

The "Preview for HDMI" function is available for HDMI BD, DVD, GAME, and VIDEO 2 input.

Tips

- This function does not work in the following cases:
 - The equipment is not connected to the HDMI input jack.
 - The equipment connected to the supported HDMI input jack is not turned on.
 - The current input is not HDMI input.
 - When "Fast View" is set to "Off".
 - When an unsupported HDMI video format (480i, 576i, 4K, some 3D video signal, some video camera signal or VGA signal) is input.

- The picture-in-picture preview will be blacked out when 4K or some 3D video signal is input.

TOP MENU¹⁾

Opens or closes the BD-ROM's or DVD's Top Menu.

POP UP/MENU¹⁾

Opens or closes the BD-ROM's Pop-up Menu, or the DVD's menu.

15 iPhone CTRL

Enters iPod/iPhone control mode when using iPod/iPhone.

MEMORY

Stores a station during tuner operation.

16 ¹⁾

Turns off the sound temporarily. Press the button again to restore the sound. Press TV (21), then press  to activate the TV's muting function.

17 ¹⁾

Adjusts the volume level of all speakers at the same time. Press TV (21), then press  to adjust the TV volume level.

18 RETURN ¹⁾

Returns to the previous menu or exits the menu while the menu or on-screen guide is displayed on the TV screen. Press TV (21), then press RETURN  to return to the previous menu of Sony TV.

19 DISPLAY¹⁾

Views information on the display panel. Press TV (21), then press DISPLAY to display information of TV.

20 ZONE (page 89)

21 TV

Changes the remote control button function to activate the buttons printed in yellow.

22 RM SET UP

Programs the remote control (page 108).

23 PURE DIRECT (page 59)

¹⁾ See the table on page 19 and 20 for information on the buttons that you can use to control each equipment.

²⁾ The VIDEO 2, 5, /D.TUNING and TV CH +/SOUND FIELD + buttons have tactile dots. Use the tactile dots as reference when operating the receiver.

Notes

- The above explanation is intended to serve as examples.
- Depending on the model of your connected equipment, some functions explained in this section may not work with the supplied remote control.



To control other Sony equipment

Name	TV	VCR	DVD player, DVD/VCR combo	Blu-ray Disc player	HDD Recorder	PSX	Video CD player, LD player
2 AV I/⏻	●	●	●	●	●	●	●
7 Numeric buttons	●	●	●	●	●	●	●
ENT	●	●	●	●	●	●	● ^{b)}
CLR			●	●		●	
-/--	●				●		
>10		●					●
9 ⏪/⏩/⏮/⏭, ⊕	●	●	●	●	●	●	
10 OPTIONS	●		●	●	●	●	
11 HOME	●	●	●	●	●	●	
12 ⏮/⏭/⏪/⏩	●	●	●	●	●	●	●
PRESET +/-							
⏮/⏭	●	●	●	●	●	●	●
▶, II, ■	●	●	●	●	●	●	●
GUIDE	●		● ^{a)}	●	●	●	
REPEAT							● ^{c)}
SHUFFLE							● ^{c)}
13 TV CH +/-	●						
14 TOP MENU, POP UP/ MENU			●	●		●	
16 🔇	●						
17 ◀ +/-	●						
18 RETURN ♂↻	●		●	●	●	●	●
19 DISPLAY	●	●	●	●	●	●	●

^{a)} DVD player only.

^{b)} LD player only.

^{c)} Video CD player only.

Name	Digital CATV terminal	DSS	Digital satellite/terrestrial receiver	Tape deck A/B	DAT deck	CD player, MD deck
2 AV I/⏻	●	●	●		●	●
7 Numeric buttons	●	●	●	●	●	●
ENT	●	●	●	●	●	●
CLR						
-/-		●	●			
>10				●		●
9 ↕/↔/↔/↔, ⊕	●	●	●			
10 OPTIONS	●	●				
11 HOME	●	●	●			
12 I◀◀/▶▶I	●			● ^{d)}	●	●
PRESET +/-		●	●			
◀◀/▶▶	●			●	●	●
▶, II, ■	●			●	●	●
GUIDE	●		●			
REPEAT				● ^{d)}	●	●
SHUFFLE						●
13 TV CH +/-						
14 TOP MENU, POP UP/MENU						
16 						
17  +/-						
18 RETURN ↻	●	●	●			
19 DISPLAY	●	●	●	● ^{d)}	●	●

^{d)} Deck B only.

Getting started

You can enjoy your audio/video equipment connected to the receiver by following the simple steps below.

Before connecting cords, be sure to disconnect the AC power cord (mains lead).

Installing and connecting the speakers (page 24, 26)



Connecting the TV and other equipment (page 28, 29)

The image quality depends on the connecting jack. See the illustration below. Select the connection according to the jacks on your equipment.

We recommend that you connect your equipment via HDMI connection if they have HDMI jacks.

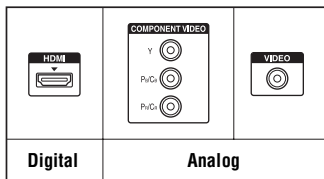

High quality image



Preparing the receiver

See “Setting the voltage selector” (page 37), “Connecting the AC power cord (mains lead)” (page 37) and “Turning on the receiver” (page 37).



Setting the receiver

See “Setting up the receiver using the Easy Setup” (page 37).



Setting the audio output settings on the connected equipment

To output multi channel digital audio, check the digital audio output setting on the connected equipment.

For a Sony Blu-ray Disc player, check that “Audio (HDMI)”, “BD Audio MIX Setting”, “Dolby Digital/DTS”, “Dolby Digital”, and “DTS” are set to “Auto”, “Off”, “Bitstream”, “Dolby Digital”, and “DTS” respectively (as of August 1, 2012).





For a PlayStation 3, after having connected the receiver with an HDMI cable, select the “Audio Output Settings” in “Sound Settings”, and select “HDMI” and “Automatic” (with system software version 4.21).

For details, refer to the operating instructions supplied with the connected equipment.

Function for conversion of video signals

The receiver is equipped with a function for converting video signals.

Video signals and component video signals can be output as HDMI video signals. As the default setting, video signals input from the connected equipment are output as shown in the table with solid arrows.

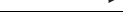
INPUT jack		OUTPUT jack
HDMI IN		HDMI OUT
COMPONENT VIDEO IN	 	COMPONENT VIDEO MONITOR OUT
VIDEO IN	 	MONITOR OUT

 : Same type of signal as that of the input signal is output.

 : Video signals are upconverted and output (up to 4K).

Notes on converting video signals

- When video signals from a VCR, etc., are upconverted on this receiver and then viewed on your TV, depending on the status of the video signal output, the image on the TV screen may appear distorted horizontally or no image can be seen.
- If you are using an image improvement circuitry with your VCR, it may impact the video signal conversion. It is recommended to turn off this function on your VCR.
- Converted HDMI image output does not support “x.v.Color (x.v.Colour)”, Deep Color (Deep Colour), and 3D.
- HDMI video signals cannot be converted to component video signals and video signals.
- 1080p component video signals cannot be upconverted.

Digital audio formats supported by the receiver

Digital audio formats that this receiver can decode depend on digital audio output jacks of the equipment connected. This receiver supports the following audio formats.

Audio format [Display]	Maximum number of channels	Connection between the playback equipment and the receiver	
		COAXIAL/OPTICAL	HDMI
Dolby Digital [DOLBY D]	5.1	○	○ ^{c)}
Dolby Digital EX [DOLBY D EX]	6.1	○	○ ^{c)}
Dolby Digital Plus ^{a)} [DOLBY D +]	7.1	×	○ ^{c)}
Dolby TrueHD ^{a)} [DOLBY HD]	7.1	×	○
DTS [DTS]	5.1	○	○ ^{c)}
DTS-ES [DTS-ES]	6.1	○	○ ^{c)}
DTS 96/24 [DTS 96/24]	5.1	○	○ ^{c)}
DTS-HD High Resolution Audio ^{a)} [DTS-HD HR]	7.1	×	○ ^{c)}
DTS-HD Master Audio ^{a)b)} [DTS-HD MA]	7.1	×	○
DSD ^{a)} [DSD]	5.1	×	○
Multi Channel Linear PCM ^{a)} [PCM]	7.1	×	○ ^{c)}

^{a)} Audio signals are output in another format if the playback equipment does not correspond to the format. For details, refer to the operating instructions of the playback equipment.

^{b)} Signals with a sampling frequency of more than 96 kHz are played back at 96 kHz or 88.2 kHz.

^{c)} These formats are supported by MHL when you connect a MHL-compatible source device to the HDMI/MHL (VIDEO 2 IN) jack.

1: Installing the speakers

This receiver allows you to use up to a 7.2 channel system (7 speakers and 2 subwoofers).

Example of speaker system configuration

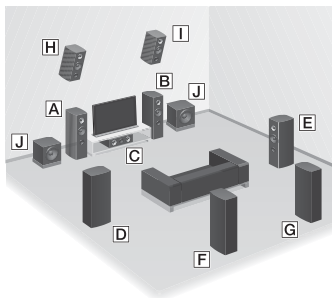

- A** Front speaker (Left)
- B** Front speaker (Right)
- C** Center speaker
- D** Surround speaker (Left)
- E** Surround speaker (Right)
- F** Surround back speaker (Left)*
- G** Surround back speaker (Right)*
- H** Front high speaker (Left)*
- I** Front high speaker (Right)*
- J** Subwoofer

* You cannot use the surround back speakers and the front high speakers simultaneously.

5.1 channel speaker system

To fully enjoy theater-like multi channel surround sound requires five speakers (two front speakers, a center speaker, and two surround speakers) and a subwoofer.

7.1 channel speaker system using surround back speakers

You can enjoy high fidelity reproduction of DVD or Blu-ray Disc software recorded sound in 6.1 channel or 7.1 channel format.

- 6.1 channel speaker placement
Place the surround back speaker behind the listening position.

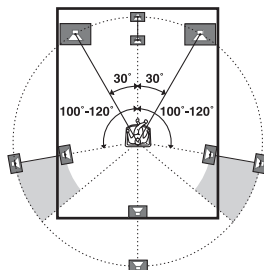

- 7.1 channel speaker placement
Place the surround back speakers as shown in the illustration below. The angle **A** should be the same.

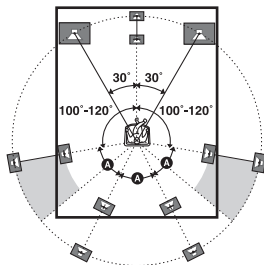

7.1 channel speaker system using front high speakers

You can enjoy vertical sound effects by connecting additional two front high speakers.

Place the front high speakers

– at an angle between 25° to 35° .

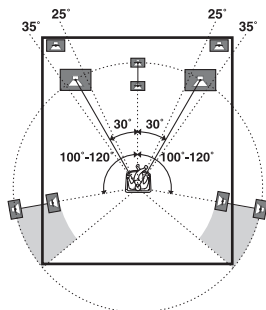

– at an angle of $20^\circ \pm 5^\circ$ in height.

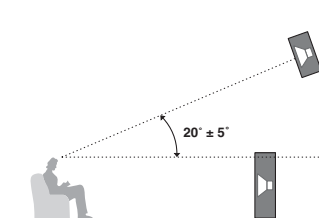

Tip

Since the subwoofer does not emit highly directional signals, you can place it wherever you want.

2: Connecting the speakers

Before connecting cords, be sure to disconnect the AC power cord (mains lead).

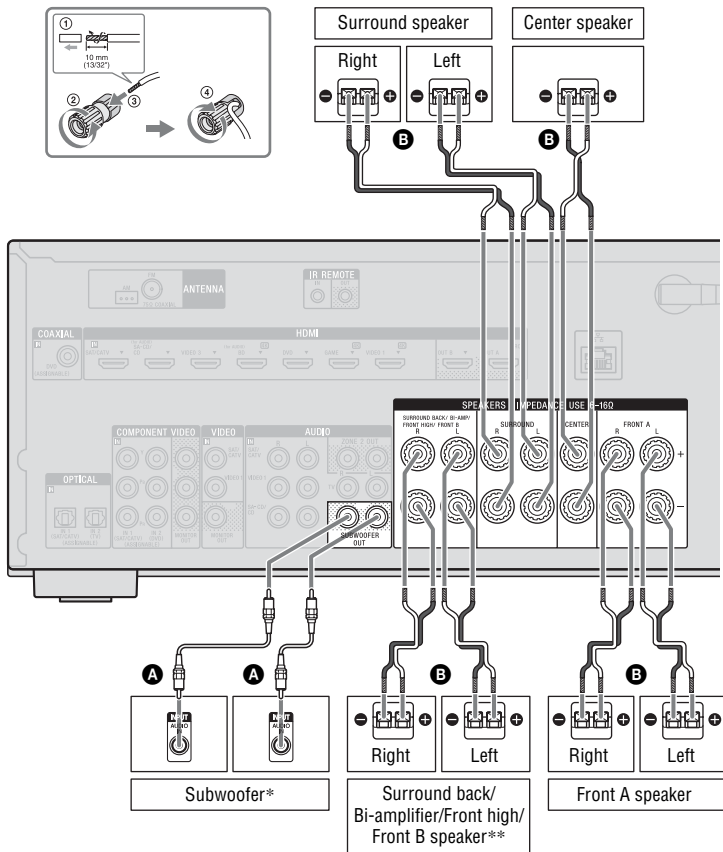

A Monaural audio cord (not supplied)

B Speaker cord (not supplied)

- * When you connect a subwoofer with an auto standby function, turn off the function when watching movies. If the auto standby function is set to on, it turns to standby mode automatically based on the level of the input signal to the subwoofer, and the sound may not be output.
- ** Notes on the SPEAKERS SURROUND BACK/BI-AMP/FRONT HIGH/FRONT B terminals connection.
 - If you connect only one surround back speaker, connect it to L of this terminals.
 - If you have an additional front speaker system, connect them to this terminals. Set the assignment for the SPEAKERS SURROUND BACK/BI-AMP/FRONT HIGH/FRONT B terminals to “Front B Speakers” by using the “Speaker Connection” in the Speaker Settings menu (page 95). You can select the front speaker system you want by using the SPEAKERS button on the receiver (page 39).
 - You can connect the front speakers to this terminals using bi-amplifier connection (page 27). Set the assignment for the SPEAKERS SURROUND BACK/BI-AMP/FRONT HIGH/FRONT B terminals to “Bi-Amplifier Connection” by using the “Speaker Connection” in the Speaker Settings menu (page 95).

Note

After you have installed and connected your speaker, be sure to select the speaker pattern you want using the “Speaker Connection” in the Speaker Settings menu (page 95).

Bi-amplifier connection

If you are not using surround back speakers and front high speakers, you can connect the front speakers to the SPEAKERS SURROUND BACK/BI-AMP/FRONT HIGH/FRONT B terminals using a bi-amplifier connection.

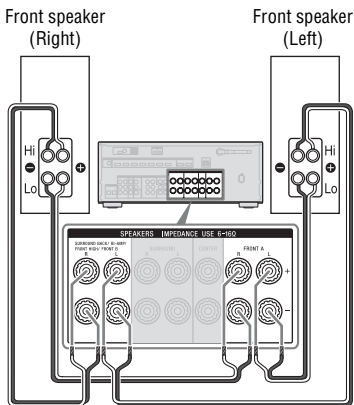

Connect the jacks on the Lo (or Hi) side of the front speakers to the SPEAKERS FRONT A terminals, and connect the jacks on the Hi (or Lo) side of the front speakers to the SPEAKERS SURROUND BACK/BI-AMP/FRONT HIGH/FRONT B terminals.

Make sure that metal fittings of Hi/Lo attached to the speakers have been removed from the speakers to avoid receiver malfunction.

After you have made the bi-amplifier connection, set the assignment for the SPEAKERS SURROUND BACK/BI-AMP/FRONT HIGH/FRONT B terminals to “Bi-Amplifier Connection” by using the “Speaker Connection” in the Speaker Settings menu (page 95).

3: Connecting the TV

You can watch the selected input image when you connect the HDMI OUT or MONITOR OUT jack to a TV. You can operate this receiver using a GUI (Graphical User Interface). GUI is only for HDMI OUT A and HDMI OUT B.

Before connecting cords, be sure to disconnect the AC power cord (mains lead).

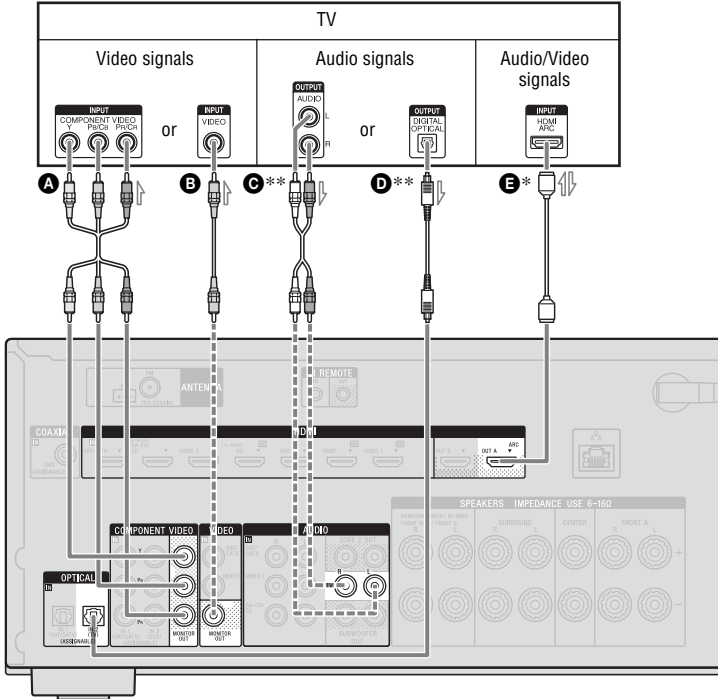

- A** Component video cord (not supplied)
- B** Video cord (not supplied)
- C** Audio cord (not supplied)
- D** Optical digital cord (not supplied)
- E** HDMI cable (not supplied)

Sony recommends that you use an HDMI-authorized cable or Sony HDMI cable.

— Recommended connection
- - - Alternative connection

To enjoy the TV broadcast in multi channel surround sound from the receiver

* If your TV is compatible with the Audio Return Channel (ARC) function, connect **E**.

Be sure to set the “Control for HDMI” to “On” in HDMI Settings menu (page 82). If you want to select an audio signal using other than an HDMI cable (e.g., via an optical digital cord or an audio cord), switch the audio input mode using INPUT MODE (page 86).

If your TV is not compatible with the ARC function, connect **C or **D**.

Be sure to turn off the TV’s volume or activate the TV’s muting function.

Notes

- Connect a TV monitor or a projector to the HDMI OUT or MONITOR OUT jack on the receiver.
- Depending on the status of the connection between the TV and the antenna (aerial), the image on the TV screen may be distorted. If this is the case, place the antenna (aerial) farther away from the receiver.
- When connecting optical digital cords, insert the plugs straight until they click into place.
- Do not bend or tie optical digital cords.

Tips

- All the digital audio jacks are compatible with 32 kHz, 44.1 kHz, 48 kHz, and 96 kHz sampling frequencies.
- The receiver has a video conversion function. For details, see “Function for conversion of video signals” (page 22).
- When you connect the audio output jack of the TV to the TV IN jacks of the receiver to output the TV sound from the speakers connected to the receiver, set the sound output jack of the TV to “Fixed” if it can be switched between either “Fixed” or “Variable”.

To listen to the sound from the TV

If your TV does not support System Audio Control function, set the “Audio Out” to “TV+AMP” in the HDMI Settings menu (page 99).

4: Connecting other equipment

Using HDMI connection

High-Definition Multimedia Interface (HDMI) is an interface which transmits video and audio signals in digital format. By connecting Sony “BRAVIA” Sync-compatible equipment using HDMI cables, operations can be simplified. See ““BRAVIA” Sync Features” (page 82).

HDMI features

- A digital audio signals transmitted by HDMI can be output from the speakers connected to the receiver. This signal supports Dolby Digital, DTS, DSD, and Linear PCM. For details, see “Digital audio formats supported by the receiver” (page 23).
- The receiver can receive Multi Channel Linear PCM (up to 8 channels) with a sampling frequency of 192 kHz or less with an HDMI connection.
- Analog video signals input to the receiver’s VIDEO jack or COMPONENT VIDEO jacks can be output as HDMI signals (page 22). Audio signals are not output from an HDMI OUT jacks while the image is being converted.
- This receiver supports High Bitrate Audio (DTS-HD Master Audio, Dolby TrueHD), Deep Color (Deep Colour), “x.v.Color (x.v.Colour)”, and 4K or 3D transmission.
- To enjoy 3D images, connect 3D-compatible TV and video equipment (Blu-ray Disc player, Blu-ray Disc recorder, PlayStation 3, etc.) to the receiver using High Speed HDMI cables, put on 3D glasses, and then play back a 3D-compatible content.

- To enjoy 4K (HDMI BD, GAME and VIDEO 1 input) images, connect 4K-compatible TV and video equipment (Blu-ray Disc player, etc) to the receiver using High Speed HDMI cables, and then play back a 4K-compatible content.
- You can view HDMI BD, DVD, GAME, and VIDEO 2 input on picture-in-picture preview.

Notes on HDMI connections

- Depending on the TV or the video equipment, 4K or 3D images may not be displayed. Check the HDMI video formats supported by the receiver (page 129).
- Refer to the operating instructions of each connected equipment for details.

When connecting cords

- Before connecting cords, be sure to disconnect the AC power cord (mains lead).
- It is not necessary to connect all the cords. Connect according to the availability of jacks on the connected equipment.
- Use a High Speed HDMI cable. If you use a Standard HDMI cable, 1080p, Deep Color (Deep Colour), 4K or 3D images may not be displayed properly.
- We do not recommend using an HDMI-DVI conversion cable. When you connect an HDMI-DVI conversion cable to a DVI-D equipment, the sound and/or the image may be lost. Connect a separate audio cords or digital connecting cords, then reassign the input jacks when the sound is not output correctly. For details, see “Using other video/audio input jacks (Input Assign)” (page 86).
- When connecting optical digital cords, insert the plugs straight until they click into place.
- Do not bend or tie optical digital cords.

Tip

All the digital audio jacks are compatible with 32 kHz, 44.1 kHz, 48 kHz, and 96 kHz sampling frequencies.

If you want to connect several digital equipment, but cannot find an unused input

See “Using other video/audio input jacks (Input Assign)” (page 86).

Converting video signals

This receiver is equipped with a function for converting video signals. For details, see “Function for conversion of video signals” (page 22).

Connecting equipment with HDMI jacks

If your equipment does not have an HDMI jack, see page 33.

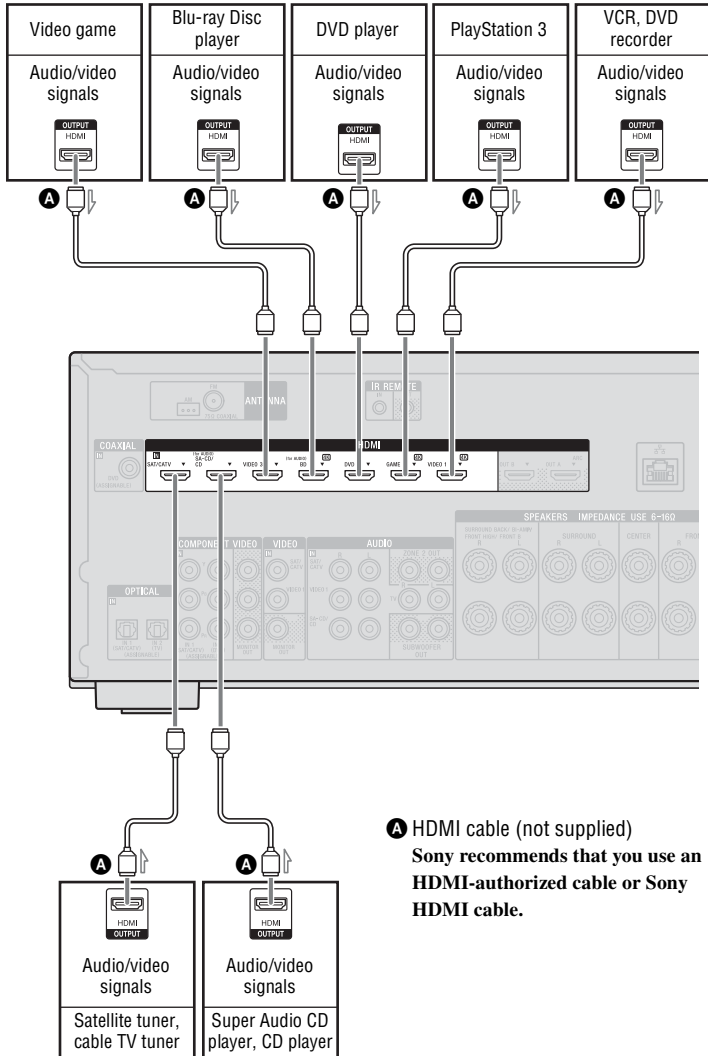

Notes

- This HDMI connection is an example.
You can connect each HDMI equipment to any HDMI inputs, including HDMI input on the front panel.
- SA-CD/CD and BD inputs have better sound quality. When you need a higher sound quality, connect your equipment to these jacks and select them as input.
- Be sure to change the default setting of the input button on the remote control so that you can use the button to control the connected equipment. For details, see “Programming the remote control” (page 108).
- You can rename the input so that it can be displayed on the receiver’s display panel. For details, see “Name” in Input Settings menu (page 100).

Using MHL connection

What is MHL?

MHL (Mobile High-Definition Link) is an HD video and digital audio interface for connecting mobile phones and portable devices to HDTVs and other home entertainment products. MHL can support 1080p HD video and digital audio signals and supply power to the mobile device simultaneously. It also enables the remote of TV or other home entertainment products to control the mobile phone and access its contents (page 85).

Connecting a MHL- (Mobile High-Definition Link) compatible mobile device for audio/video contents

This receiver incorporates MHL 2 technology.

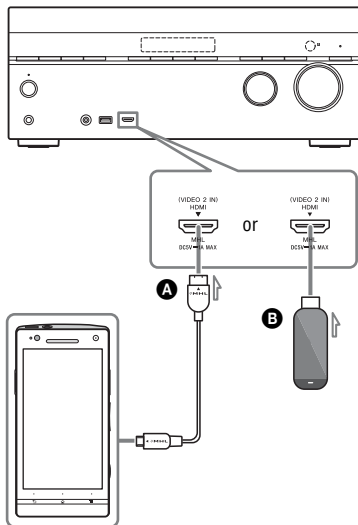

- **A** MHL cable (not supplied)
Use **MHL2-compliant cable**.
Sony recommends that you use **Sony MHL cable**.
- **B** MHL Direct Attach Device (not supplied)

Notes

- The MHL-compatible mobile device is charged when connected to the HDMI/MHL (VIDEO 2 IN) jack of the receiver while the receiver is turned on.
- You can rename the VIDEO 2 input so that it can be displayed on the receiver’s display panel. For details, see “Name” in Input Settings menu (page 100).

Connecting equipment with jacks other than HDMI jacks

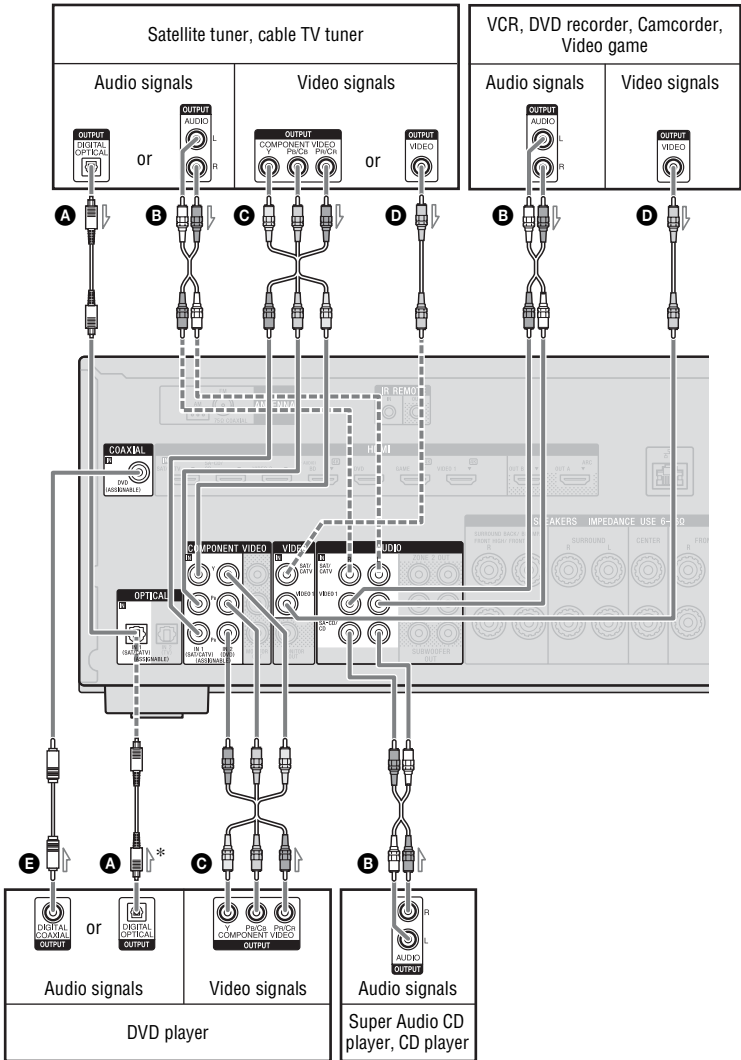

- A** Optical digital cord (not supplied)
- B** Audio cord (not supplied)
- C** Component video cord (not supplied)
- D** Video cord (not supplied)
- E** Coaxial digital cord (not supplied)

———— Recommended connection

----- Alternative connection

* When you connect equipment with an OPTICAL jack, reassign the input jacks. For details, see “Using other video/audio input jacks (Input Assign)” (page 86).

Notes

- Be sure to change the default setting of the VIDEO 1 input button on the remote control so that you can use the button to control your DVD recorder. For details, see “Programming the remote control” (page 108).
- You can rename the VIDEO 1 input so that it can be displayed on the receiver’s display panel. For details, see “Name” in Input Settings menu (page 100).

Connecting an iPod, iPhone, USB device

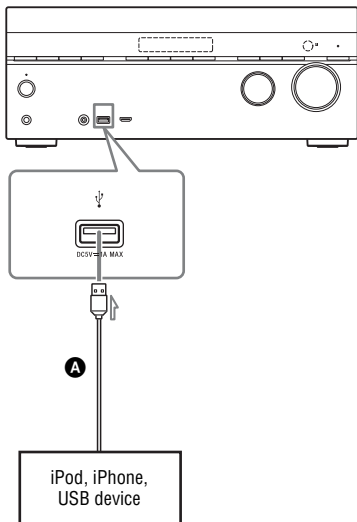

- A** USB cable (not supplied)

5: Connecting the antennas (aerials)

Before connecting the antennas (aerials), be sure to disconnect the AC power cord (mains lead).

AM loop antenna (aerial)
(supplied)

FM wire antenna (aerial)
(supplied)

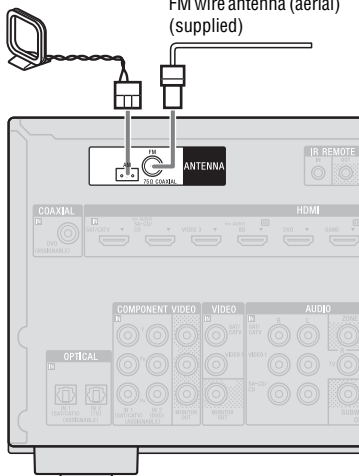

Notes

- To prevent noise pickup, keep the AM loop antenna (aerial) away from the receiver and other equipment.
- Be sure to fully extend the FM wire antenna (aerial).
- After connecting the FM wire antenna (aerial), keep it as horizontal as possible.

6: Connecting to the network

If you have an Internet connection, you can connect this receiver to the Internet as well. You can connect through a wireless or a wired LAN connection.

System requirements

The following system environment is required to use the network function of the receiver.

A Broadband line connection

A Broadband line connection to the Internet is required in order to listen to Sony Entertainment Network (SEN) and to update the software of the receiver.

Modem

This is the device that is connected to the broadband line to communicate with the Internet. Some of these devices are integrated with the router.

Router

- Use a router compatible with 100 Mbps or greater transmission speeds to enjoy content on your home network.
- We recommend that you use a router equipped with the built-in DHCP (Dynamic Host Configuration Protocol) server.
This function automatically assigns IP addresses on the LAN.
- Use a wireless LAN router/access point if you want to use a wireless LAN connection.

LAN cable (CAT5) (For a wired LAN connection only)

- We recommend that you use this type of cable for a wired LAN.
Some flat-type LAN cables are easily affected by noise. We recommend that you use normal-type cables.
- If the receiver is used in an environment in which there is power supply noise from electric products or in a noisy network environment, use a shielded-type LAN cable.

Server

A server is a device which delivers content (music, photos, and videos) to a DLNA device on a home network. A device that can be used as a server (a computer, etc.) must be connected to your wireless or wired LAN home network*.

* For details on servers which are compatible with this receiver, see page 61.

Configuration example

The following illustration is a configuration example of a home network with the receiver and a server.

We recommend that you connect the server to the router with a wired connection.

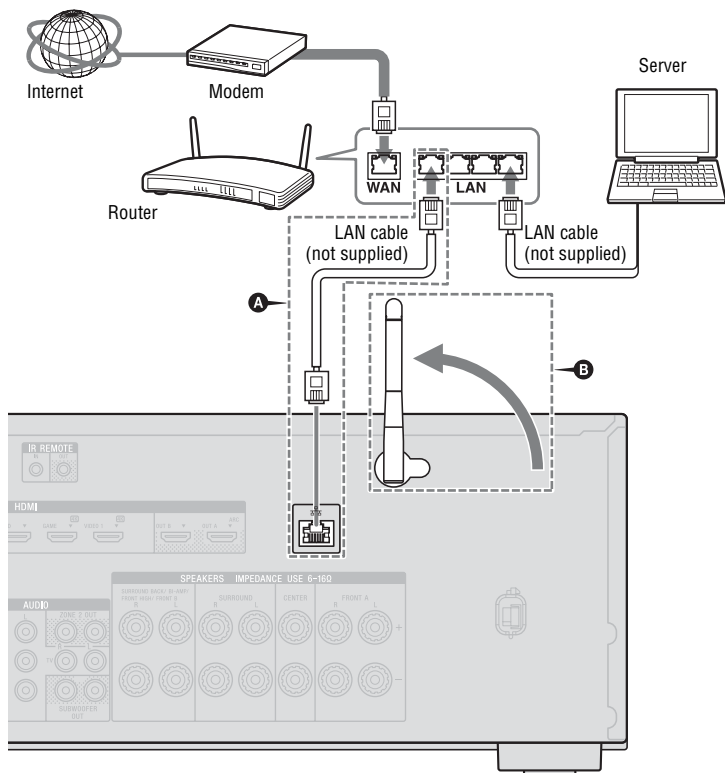

A For a wired LAN connection only.

B For a wireless LAN connection only.

Be sure to use a wireless LAN router/access point.

Note

An audio playback on a server may occasionally be interrupted when you use a wireless connection.

Preparing the Receiver

Setting the voltage selector

If your receiver has a voltage selector on the rear panel, check that the voltage selector is set to the local power supply voltage. If not, use a screwdriver to set the selector to the correct position before connecting the AC power cord (mains lead) to a wall outlet.

Depending on the area, the VOLTAGE SELECTOR may differ.

Connecting the AC power cord (mains lead)

Connect the AC power cord (mains lead) to a wall outlet.

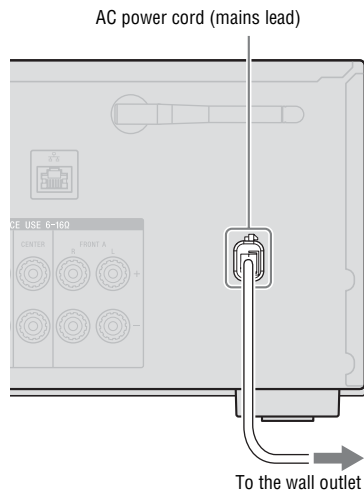

Turning on the receiver

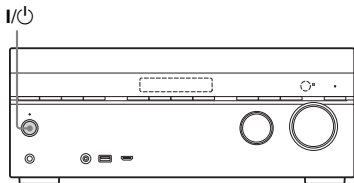

Press I/O to turn on the receiver.

You can also turn on the receiver using I/O on the remote control. When you turn off the receiver, press I/O again. "STANDBY" flashes on the display panel. Do not disconnect the AC power cord (mains lead) while "STANDBY" is flashing. This may cause a malfunction.

Setting up the receiver using the Easy Setup

You can set the basic settings of the receiver easily by operating the receiver in accordance with the instructions on the TV screen.

Switch the input of the TV to the input which the receiver is connected.

When you turn on the receiver for the first time or after the receiver is initialized, the Easy Setup screen appears on the TV screen. Proceed to set up the receiver in accordance with the instructions on the Easy Setup screen.

You can set up the following functions using the Easy Setup.

- Speaker Settings
- Network Settings

Notes on Speaker Settings (Auto Calibration)

This receiver is equipped with DCAC (Digital Cinema Auto Calibration) function which allows you to perform automatic calibration as follows:

- Check the connection between each speaker and the receiver.
- Adjust the speaker level.
- Measure the distance of each speaker from your seating position.¹⁾
- Measure the speaker size.¹⁾
- Measure the frequency characteristics (EQ).¹⁾
- Measure the frequency characteristics (Phase).¹⁾²⁾

¹⁾The measurement result is not utilized when “2ch Analog Direct” is selected.

²⁾The measurement result is not utilized when Dolby TrueHD or DTS-HD signals with a sampling frequency of more than 48 kHz are being received.

The DCAC is designed to achieve proper sound balance for your room. However, you can adjust the speaker levels manually according to your preference. For details, see “Test Tone” (page 97).

Before you perform Auto Calibration

Before you perform Auto Calibration, check the following items.

- Set up and connect the speakers (page 24, 26).
- Connect only the supplied optimizer microphone to the AUTO CAL MIC jack. Do not connect any other microphones to this jack.
- Set the assignment for the SPEAKERS SURROUND BACK/BI-AMP/FRONT HIGH/FRONT B terminals to “Bi-Amplifier Connection” by using the “Speaker Connection” in the Speaker Settings menu if you use bi-amplifier connection (page 95).

- Set the assignment for the SPEAKERS SURROUND BACK/BI-AMP/FRONT HIGH/FRONT B terminals to “Front B Speakers” by using the “Speaker Connection” in the Speaker Settings menu if you use speakers front B connection (page 95).
- Make sure the speaker output is not set to “SPK OFF” (page 39).
- Make sure that you are not using PARTY STREAMING function (page 72).
- Disconnect the headphones.
- Remove any obstacles in the path between the optimizer microphone and the speakers to avoid measurement errors.
- Get accurate measurement by making sure the environment is free from noise and quiet.

Notes

- The speakers emit very loud sound during the calibration and the volume cannot be adjusted. Provide consideration to your neighborhood and to the children in presence.
- If the muting function has been activated before you perform Auto Calibration, the muting function will shut off automatically.
- The correct measurements may not be able to take or Auto Calibration cannot be performed when special speakers, such as dipole speakers are used.

Confirm active subwoofer setup

- When a subwoofer is connected, turn on the subwoofer and turn up the volume prior to activating the subwoofer. Turn the LEVEL to just before the mid-point.
- If you connect a subwoofer with a crossover frequency function, set the value to maximum.
- If you connect a subwoofer with an auto standby function, set it to off (deactivated).

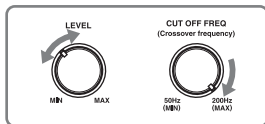

Note

Depending on the characteristics of the subwoofer you are using, the setup distance value may be different from the actual position.

To select the front speakers

You can select the front speakers you want to drive.

Be sure to use the buttons on the receiver to perform this operation.

SPEAKERS

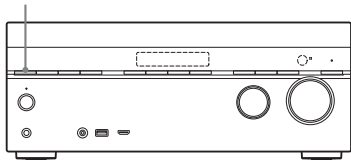

Press SPEAKERS repeatedly to select the front speaker system you want to drive.

You can confirm the selected speakers terminals by checking the indicators on the display panel.

Indicators	Selected speakers
SP A	The speakers connected to the SPEAKERS FRONT A terminals.
SP B*	The speakers connected to the SPEAKERS SURROUND BACK/BI-AMP/Front HIGH/FRONT B terminals.
SP A+B*	The speakers connected to both the SPEAKERS FRONT A and SPEAKERS SURROUND BACK/BI-AMP/Front HIGH/FRONT B terminals (parallel connection).
	"SPK OFF" appears on the display panel. No audio signals are output from any speaker terminals.

* To select "SP B" or "SP A+B", set the assignment for the SPEAKERS SURROUND BACK/BI-AMP/Front HIGH/FRONT B terminals to "Front B Speakers" by using the "Speaker Connection" in the Speaker Settings menu (page 95).

Note

This setting is not available when headphones are connected.

To cancel Auto Calibration

The Auto Calibration function will be canceled when you perform the following during the measurement process:

- Press I/O.
- Press the input buttons on the remote control or turn the INPUT SELECTOR on the receiver.
- Press .
- Press SPEAKERS on the receiver.
- Change the volume level.
- Connect the headphones.

To set up the receiver manually

See "Adjusting Settings" (page 90).

Configuring the network settings of the receiver

The network settings for the receiver must be set correctly to use the Home Network, SEN, AirPlay, and PARTY STREAMING functions.

Using a wireless LAN connection

There are several connecting methods you can use to set up a wireless network: searching for an access point, using a WPS connecting method (either the push-button method or the PIN code method), or manual setting.

Notes

- Make sure not to use the wireless LAN function where medical equipment (such as a pacemaker) is used or where the use of wireless communication is prohibited.
- Before connecting to your home network, you need to prepare a wireless LAN router/access point. For details, refer to the operating instructions of the device.
- Depending on your home network environment, the wireless LAN router/access point may have been set up such that it cannot be connected using WPS, even though it is compatible with WPS. For details on whether your wireless LAN router/access point is compatible or not compatible with WPS, and on the setup of a WPS connection, refer to the operating instructions of your wireless LAN router/access point.
- You may encounter setup difficulties if the receiver and the wireless LAN router/access point are located too far from each other. If you do, move the devices closer to each other.

Searching for an access point and setting up a wireless network (Access Point Scan method)

You can set up a wireless network by searching for an access point. To set up the network using this connection method, you will be required to select or enter the following information. Check the following information in advance, and record it in the space provided below.

- The network name (SSID*) that identifies your network**.** (This will be needed in step 7.)
: _____
- If your wireless home network is secured by encryption, the security key (WEP key, WPA/WPA2 key) for your network**.** (This will be needed in step 8.)
: _____

* SSID (Service Set Identifier) is a name that identifies a particular access point.

** This information should be available from a label on your wireless LAN router/access point, from the operating instructions, from the person who set up your wireless network, or from the information provided by your Internet service provider.

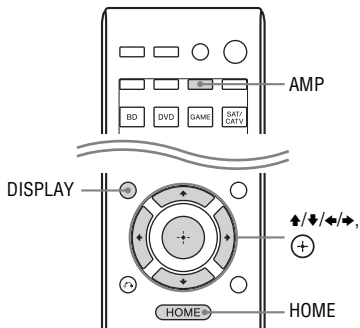

- 1 Press AMP, then press HOME.**
The home menu is displayed on the TV screen.
- 2 Press \leftarrow/\rightarrow repeatedly to select "Settings", then press \oplus .**
The Settings menu list appears on the TV screen.
- 3 Press $\uparrow/\downarrow/\leftarrow/\rightarrow$ repeatedly to select "Network", then press \oplus .**
- 4 Press \uparrow/\downarrow repeatedly to select "Internet Setting", then press \oplus .**
- 5 Press \uparrow/\downarrow repeatedly to select "Wireless", then press \oplus .**
- 6 Press \uparrow/\downarrow repeatedly to select "Access Point Scan", then press \oplus .**
The receiver starts searching for access points, and displays a list of up to 30 available network name (SSID).
- 7 Press \uparrow/\downarrow repeatedly to select the network name (SSID) you want, then press \oplus .**
The security setting display appears on the TV screen.

- 8** Enter the security key (WEP key, WPA/WPA2 key) using the on-screen keyboard. Press **▲/▼/◀/▶** and **⊕** to select the character one by one. Then, select “Enter” and press **⊕** to confirm the security key.

“How to acquire the IP Address” appears on the TV screen.

- 9** Press **▲/▼** repeatedly to select “Auto”, then press **⊕**.

When using a fixed IP address

Select “Manual”, then press **⊕**. The IP address input display appears on the TV screen.

Enter the value for “IP Address” using the on-screen keyboard. Press **▲/▼/◀/▶** and **⊕** to select the character one by one. Then, select “Enter” and press **⊕** to confirm the value.

Enter the value for “Subnet Mask”, “Default Gateway”, “Primary DNS” and “Secondary DNS”. Then, select “Next” and press **⊕**.

- 10** Press **▲/▼** repeatedly to select “Ok”, then press **⊕**.

“Connecting to the network. Please wait.” appears on the TV screen. “Network Settings are now complete and the receiver has been successfully connected to the network.” appears after the network settings are completed and “” lights up on the display panel. To return to the Network Settings menu, press **⊕**. (Depending on the network environment, the network settings may take some time.)

- 11** Perform the server settings.

To listen to audio content stored on the server, you need to set up your server (page 61).

Note

If your network has not been secured by encryption (using the security key), the security setting display does not appear in step 8.

Tip

When checking the network settings, see “Information” (page 101).

If you cannot find the network name (SSID) you want (manual setup method)

You can input the network name (SSID) you want manually if it does not appear on the list.

- 1 Select “Manual Registration” in step 6 in “Searching for an access point and setting up a wireless network (Access Point Scan method)” (page 40).
- 2 Press **▲/▼** repeatedly to select “Direct Input”, then press **⊕**.
- 3 Enter the network name (SSID) using the on-screen keyboard. Press **▲/▼/◀/▶** and **⊕** to select a character one by one. Then, select “Enter” and press **⊕**.
The name you entered is registered.
- 4 Press **▲/▼** repeatedly to select the security setting you want, then press **⊕**.
- 5 Follow steps 8 to 11 in “Searching for an access point and setting up a wireless network (Access Point Scan method)” (page 40).

Setting up a wireless network using an access point compliant with WPS

You can easily set up a wireless network using an access point compliant with WPS. The WPS setting can be made using either the push-button configuration method or the PIN (Personal Identification Number) code method.

What is WPS (Wi-Fi Protected Setup)?

WPS is a standard created by the Wi-Fi Alliance allowing you to setup a wireless network easily and securely.

Setting up a wireless network using the WPS push button configuration method



You can easily set up a WPS wireless connection with one push of the designated button.

- 1 Select “WPS Push” in step 6 in “Searching for an access point and setting up a wireless network (Access Point Scan method)” (page 40).
- 2 Follow the on-screen instructions, and press the WPS button on the access point.

Message: “Push the WPS button on the access point within 2 minutes.”



WPS button on the wireless LAN router/access point

“Network Settings are now complete and the receiver has been successfully connected to the network.” appears after the network settings are complete and “” lights up on the display panel. To return to the Network Settings menu, press . (Depending on the network environment, the network settings may take some time.)

- 3 Perform the server settings.



To listen to audio content stored on the server, you need to set up your server (page 61).

Tip

When checking the network settings, see “Information” (page 101).



Setting up a wireless network using the WPS PIN code method

If the access point supports the WPS PIN (Personal Identification Number) code connection, you can set up a WPS wireless connection by entering the receiver’s PIN code into the wireless LAN router/access point.



- 1 Select “Manual Registration” in step 6 in “Searching for an access point and setting up a wireless network (Access Point Scan method)” (page 40).
- 2 Press  repeatedly to select “WPS PIN”, then press . The available SSID (access point) list appears.

Note

SSID that does not support WPS PIN will appear dimmed and cannot be selected.

- 3 Press  repeatedly to select the network name (SSID) you want, then press .

The PIN code (8 digits) of the receiver appears on the TV screen. Leave the PIN code displayed until the connection is complete. (A different PIN code is displayed each time you perform this operation.)

- 4 Input the receiver’s PIN code into the wireless LAN router/access point. The receiver starts the network settings. “Network Settings are now complete and the receiver has been successfully connected to the network.” appears after the network settings are complete and “” lights up on the display panel. To return to the Network Settings menu, press . (Depending on the network environment, the network settings may take some time.)

5 Perform the server settings.

To listen to audio content stored on the server, you need to set up your server (page 61).

Tips

- When checking the network settings, see “Information” (page 101).
- For details on entering the PIN code into the wireless LAN router/access point, refer to the operating instructions of the wireless LAN router/access point.

Using a wired LAN connection

- 1 Select “Wired” in step 5 in “Searching for an access point and setting up a wireless network (Access Point Scan method)” (page 40).

“How to acquire the IP Address” appears on the TV screen.

- 2 Press **↕/↔** repeatedly to select “Auto”, then press **⊕**.

When using a fixed IP address

Select “Manual”, then press **⊕**. The IP address input display appears on the TV screen.

Enter the value for “IP Address” using the on-screen keyboard. Press **↕/↔/↔/↔** and **⊕** to select the character one by one. Then, select “Enter” and press **⊕** to confirm the value.

Enter the value for “Subnet Mask”, “Default Gateway”, “Primary DNS” and “Secondary DNS”. Then, select “Next” and press **⊕**.

- 3 Press **↕/↔** repeatedly to select “Ok”, then press **⊕**.

“Connecting to the network. Please wait.” appears on the TV screen.

“Network Settings are now complete and the receiver has been successfully connected to the network.” appears after the network settings are completed. To return to the Network Settings menu, press **⊕**. (Depending on the network environment, the network settings may take some time.)

4 Perform the server settings.

To listen to audio content stored on the server, you need to set up your server (page 61).

Tip

When checking the network settings, see “Information” (page 101).

Guide to on-screen display operation

You can display the menu of the receiver on the TV screen and select the function you want to use on the TV screen by pressing **↕/↔/↔/↔** and **⊕** on the remote control.

When you start operating the receiver, make sure to press AMP on the remote control first. Otherwise, operations that follow may not be aimed at the receiver.

Tip

The AMP button on the remote control lights up when you press HOME.

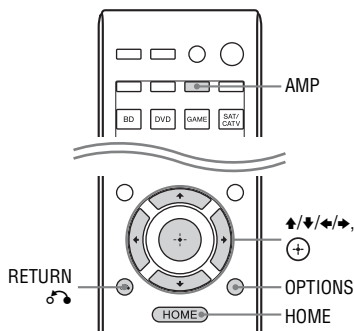

Using the menu

- 1 Switch the input of the TV to the input which the receiver is connected.
- 2 Press **AMP**, then press **HOME**.
The home menu is displayed on the TV screen.
Depending on the TV, the home menu may take some time to appear on the TV screen.

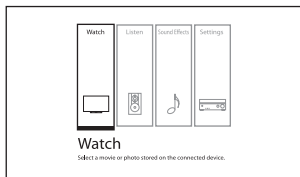

- 3 Press **←/→** repeatedly to select a menu you want, then press **+** to enter the menu.

The menu item list appears on the TV screen.

Example: When you select “Watch”.

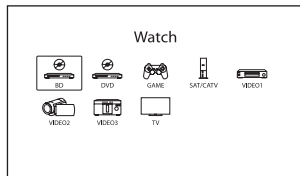

- 4 Press **↑/↓/←/→** repeatedly to select the menu item you want to adjust, then press **+** to enter the menu item.

Tip

When “OPTIONS” appears in the lower right portion of the screen, you can display the function list by pressing **OPTIONS** and selecting a related function.

To return to the previous screen

Press **RETURN** .

To exit the menu

Press **HOME** to display the home menu, then press **HOME** again.

Overview of the home menus

Menu	Description
Watch	Selects the video source to be input to the receiver (page 45).
Listen	Selects the music from the SA-CD/CD, USB device, <i>Bluetooth</i> device, Home Network, or SEN (page 45). You can also enjoy FM/AM radio of the built-in receiver (page 52).
Sound Effects	Enables you to enjoy sound development provided by various Sony proprietary technologies or functions (page 55).
Settings	Adjusts the settings of the receiver (page 90).

Basic Operations

Enjoying images/sound from the connected equipment

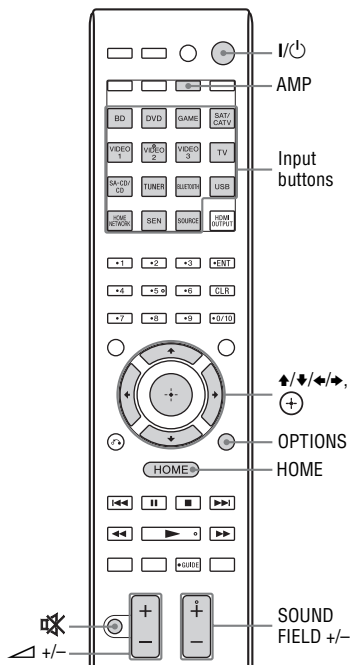

- 1** Switch the input of the TV to the input which the receiver is connected.
- 2** Press AMP, then press HOME. The home menu is displayed on the TV screen.

Depending on the TV, the home menu may take some time to appear on the TV screen.

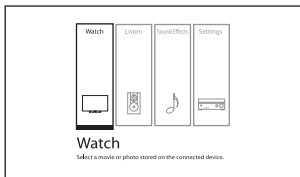

- 3** Select “Watch” or “Listen”, then press **+**.
The menu item list appears on the TV screen.
- 4** Select the equipment you want, then press **+**.
- 5** Turn on the equipment and start playback.
- 6** Press **▲ +/-** to adjust the volume.
You can also use MASTER VOLUME on the receiver.
- 7** Press **SOUND FIELD +/-** to enjoy the surround sound.
You can also use A.F.D./2CH, MOVIE or MUSIC on the receiver.
For details, see page 55.

Tips

- You can turn INPUT SELECTOR on the receiver or press input buttons on the remote control to select the equipment you want.
- You can adjust the volume differently using the MASTER VOLUME knob on the receiver or the **▲ +/-** button on the remote control.
To turn the volume up or down quickly
 - Turn the knob quickly.
 - Press and hold the button.To make fine adjustment
 - Turn the knob slowly.
 - Press the button and release it immediately.

To activate the muting function

Press **MUTE**.

The muting function will be canceled when you do the following.

- Press **MUTE** again.
- Change the volume.
- Turn off the receiver.
- Perform Auto Calibration.

To avoid damaging your speakers

Before you turn off the receiver, be sure to turn down the volume level.

Playing an iPod/iPhone

You can enjoy music contents from the iPod/iPhone by connecting it to the ψ (USB) port on the receiver.

For details on connecting the iPod/iPhone, see page 34.

Compatible iPod/iPhone models

You can use the following iPod/iPhone models on this receiver. Update your iPod/iPhone with the latest software before using it.



iPhone 4S



iPhone 4



iPhone 3GS



iPhone 3G



iPod touch
4th generation



iPod touch
3rd generation



iPod touch
2nd generation



iPod nano
6th generation



iPod nano
5th generation
(video camera)



iPod nano
4th generation
(video)



iPod nano
3rd generation
(video)



iPod classic

Notes

- Sony cannot accept responsibility in the event that data recorded to iPod/iPhone is lost or damaged when using an iPod/iPhone connected to this receiver.
- This product has been designed specifically to work with iPod/iPhone and has been certified to meet Apple performance standards.

Selecting the iPod/iPhone control mode

You can select the iPod/iPhone control mode using the iPhone CTRL on the remote control.

You can also control all operations by viewing the information on the display panel when TV screen is turned off.

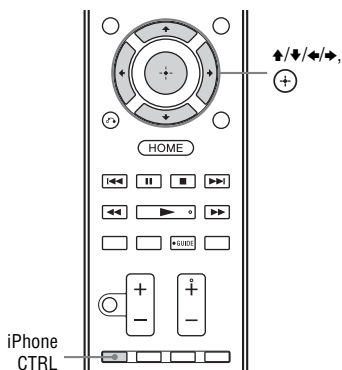

- 1 Select "Listen" from the home menu, then press (+).
- 2 Select "USB", then press (+). When the iPod or iPhone is connected, "iPod/iPhone" appears on the TV screen.
- 3 Follow the on-screen instructions to select the iPod/iPhone control mode.

To operate the iPod/iPhone using the remote control

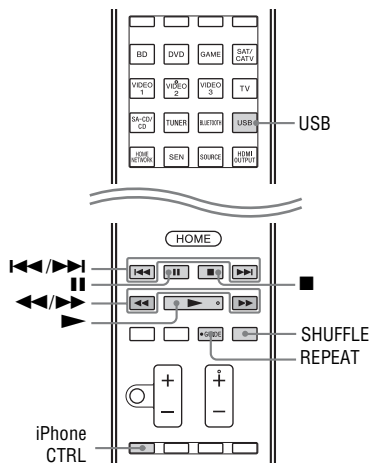

Press USB before you use the following buttons.

Press	Operation
▶	Starts play.
⏸, ■	Pauses play.
◀▶	Fast reverses or forwards.
◀◀/▶▶	Goes to the previous/next track.
REPEAT	Enters repeat mode.
SHUFFLE	Enters shuffle mode.
iPhone CTRL	Selects the iPod/iPhone control mode.

Notes on iPod/iPhone

- The iPod/iPhone is charged when connected to the receiver while the receiver is turned on.
- You cannot transfer songs onto the iPod/iPhone from this receiver.

- Do not remove the iPod/iPhone during operation. To avoid data corruption or damage to the iPod/iPhone, turn the receiver off when connecting or removing the iPod/iPhone.

iPod/iPhone message list

Message and explanation

Reading

The receiver is recognizing and reading information of the iPod or iPhone.

Not supported

An unsupported iPod or iPhone is connected.

No device is connected

No iPod or iPhone is connected.

No Track

No track was found.

Headphone is not supported

No sound is output from the headphones when iPod or iPhone is connected.

Playing a USB device

You can enjoy music from the USB device by connecting it to the ψ (USB) port on the receiver.

For details on connecting a USB device, see “Connecting an iPod, iPhone, USB device” (page 34).

The music file formats that can be played back by this receiver are as follows:

File format	Extensions
MP3 (MPEG-1 Audio Layer III)	“.mp3”
AAC*	“.m4a”, “.3gp”, “.mp4”
WMA9 Standard*	“.wma”
WAV	“.wav”
FLAC	“.flac”

* The receiver does not play files encoded with DRM.

Compatible USB devices

You can use the following Sony USB devices on this receiver.

Verified Sony USB device

Product name	Model name	
Walkman®	NWZ-A864	
	NWZ-B152F / B162F / B172	
	NWZ-E053 / E354 / E363 / E373 / E453 / E463 / E575	
	NWZ-F805 / F806N	
	NWZ-S755 / S764 / S774 / S774BT	
	NWZ-W262 / W272	
	NWZ-Z1040 / Z1070	
	NWD-W253	
	MICROVAULT	USM1GL / 4GL / 8GL / 32GL
		USM16GLX / 32GLX / 64GLX
USM4GN / 8GN / 32GN		
USM4GM / 16GM		
USM8GQ / 32GQ / 64GQ		
USM16GR / 32GR		
USM4GS / 8GJ / 8GT / 16GS / 16GU / 64GP / 512J		
Digital Voice Recorder	ICD-SX713 / SX1000 / PX232 / PX333F / FX8 / TX50 / UX513F / UX523F / UX532 / UX533F	
	ICZ-R50 / R51	

Notes

- The receiver is unable to read data in NTFS format.
- The receiver is unable to read data other than that saved in the first partition of a hard disk drive.
- Operation of models not listed here is not guaranteed.
- Operation may not always be ensured even when using these USB devices.
- Some of these USB devices may not be available for purchase in certain areas.
- When formatting the above models, be sure to format using the model itself or the dedicated formatting software for that model.
- When connecting a USB device to the receiver, be sure to connect after the display “Creating Library” or “Creating Database” on the USB device has disappeared.

Operating the USB device

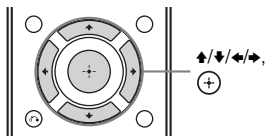



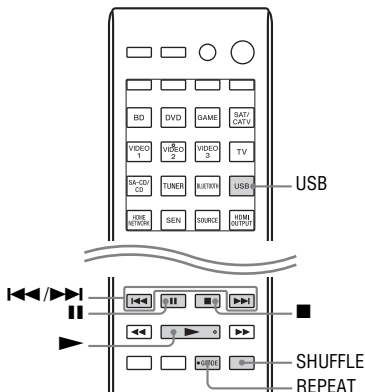

- 1 Select “Listen” from the home menu, then press (+).**
- 2 Select “USB”, then press (+).**
When the USB device is connected, “USB” appears on the TV screen. You can operate the USB device using the remote control of the receiver.
- 3 Select the content you want from the content list, then press (+).**
The selected content starts playback and the information of music contents appears on the TV screen.

To operate the USB device using the remote control



Press USB before you use the following buttons.

Press	Operation
	Starts play.
	Pauses play.
	Stops play.
	Goes to the previous/next file.
REPEAT	Enters repeat mode.
SHUFFLE	Enters shuffle mode.

Notes on the USB device

- Do not remove the USB device during operation. To avoid data corruption or damage to the USB device, turn the receiver off when connecting or removing the USB device.
- When USB cable connection is necessary, connect the USB cable supplied with the USB device to be connected. Refer to the operating instructions supplied with the USB device to be connected for details on the operation method.

- Do not connect the receiver and the USB device through a USB hub.
- When the USB device is connected, “Reading” appears.
- It may take about 10 seconds before “Reading” appears depending on the type of USB device connected.
- When the USB device is connected, the receiver reads all the files on the USB device. If there are many folders or files on the USB device, it may take a long time to finish reading the USB device.
- The receiver can recognize up to
 - 256 folders (including “ROOT” folder).
 - 256 audio files for each folder.
 - 8 folder levels (tree structure of files, including “ROOT” folder).
 The maximum number of audio files and folders may vary depending on the file and folder structure.
 Do not save other types of files or unnecessary folders on a USB device.
- Compatibility with all encoding/writing softwares, recording devices, and recording media cannot be guaranteed. Incompatible USB device may produce noise or interrupted audio or may not play at all.
- Some time may be needed to start playback when:
 - the folder structure is complex.
 - the memory capacity is excessive.
- This receiver does not necessarily support all the functions provided in a connected USB device.
- The playback order for the receiver may differ from the playback order of the connected USB device.
- Folders that have no audio files are skipped.
- When playing a very long track, some operations may cause playback delay.

USB message list

Message and explanation

Reading

The receiver is recognizing and reading information of the USB device.

Device error

The memory of the USB device could not be recognized (page 49).

Not supported

An unsupported USB device is connected, an unknown device is connected, or the USB device is connected through a USB hub (page 49).

No device is connected

No USB device is connected or the connected USB device is not recognized.

Cannot get info

The number of audio files/folders/folder levels reaches the limit for the number that the receiver can recognize (page 51).

Cannot play

The receiver cannot play audio files due to an unsupported file format or playback restrictions.

Not in Use

An operation that is currently prohibited is being performed.

No Track

No track was found.

Tuner Operations

Listening to FM/AM radio

You can listen to FM and AM broadcasts through the built-in tuner. Before operation, be sure you have connected the FM and AM antennas (aerials) to the receiver (page 34).

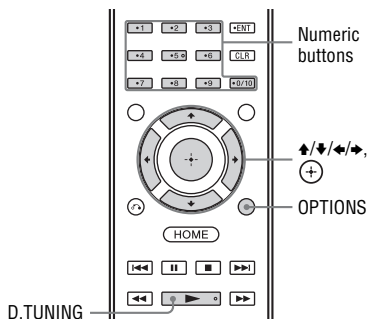

- 1 Select "Listen" from the home menu, then press \oplus .
- 2 Select "FM/AM", then press \oplus .

FM/AM screen

You can select and operate each item on the screen by pressing $\uparrow/\downarrow/\leftarrow/\rightarrow$ and \oplus .

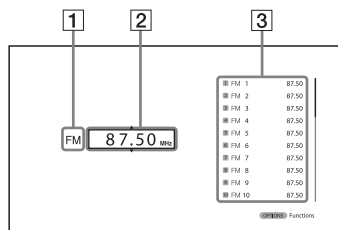

- 1 Band indication (page 52)
- 2 Frequency indication (page 52)
- 3 Preset station list (page 54)

Toggling between FM and AM radio

- 1 Select "Listen" from the home menu, then press \oplus .
- 2 Select "FM/AM", then press \oplus . The FM/AM screen appears.
- 3 Select the band indication.
- 4 Press \uparrow/\downarrow repeatedly to select "FM" or "AM", then press \oplus .

Tuning to a station automatically (Auto Tuning)

- 1 Select the frequency indication on the FM/AM screen.
- 2 Press \uparrow/\downarrow . Press \uparrow to scan from lower to higher frequency stations, press \downarrow to scan from higher to lower stations. The receiver stops scanning whenever a station is received.

In case of poor FM stereo reception

- 1 Tune in the station you want to listen to using Auto Tuning, Direct Tuning, or select the preset station you want (page 52).
- 2 Press OPTIONS. The options menu appears.

Note

You can set FM mode in the options menu when the frequency indication is selected.

- 3 Select "STEREO/MONO", then press \oplus .
- 4 Select "MONO", then press \oplus .

Tuning to a station directly (Direct Tuning)

You can enter the frequency of a station directly by using the numeric buttons.

- 1 Press **D.TUNING**.
- 2 Press the numeric buttons to enter the frequency, then press **+**.

Example 1: FM 102.50 MHz

Select 1 → 0 → 2 → 5 (→ 0*)

Example 2: AM 1,350 kHz

Select 1 → 3 → 5 → 0

* Press 0 for Mexico model only.

Tips

- Adjust the direction of the AM loop antenna (aerial) for optimum reception upon tuning to an AM station.
- The tuning scale for direct tuning is shown below.

Area	FM	AM
USA, Canada, Brazil	100 kHz	10 kHz*
Mexico	50 kHz	10 kHz*

*The AM tuning scale can be changed (page 53).

If you cannot tune to a station

“----,-- MHz” or “----- kHz” appears and then the screen returns to the current frequency.

Make sure you have entered the right frequency. If not, repeat step 2. If you still cannot tune to a station, the frequency may not be in use in your area.

Changing the AM tuning scale

You can change the AM tuning scale to either 9 kHz or 10 kHz using the buttons on the receiver.

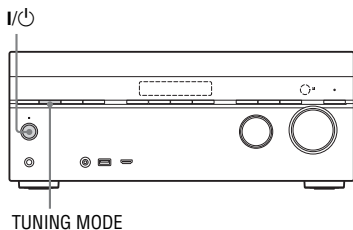

- 1 Press **I/O** to turn off the receiver.
- 2 While holding down **TUNING MODE**, press **I/O** on the receiver.

The current AM tuning scale is changed to 9 kHz (or 10 kHz). To reset the scale to 10 kHz (or 9 kHz), repeat the procedure above.

Notes

- Depending on the settings, the receiver may take some time to change the AM tuning scale.
- All preset stations will be erased when you change the tuning scale.

Presetting FM/AM radio stations

(Preset Memory)

You can store up to 30 FM and 30 AM stations as your favorite stations.

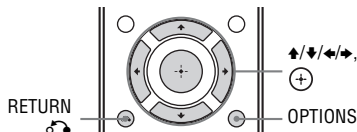

- 1 Tune to the station that you want to preset using Auto Tuning (page 52) or Direct Tuning (page 53).**
- 2 Press OPTIONS.**
The options menu appears.

Note

You can preset memory in the options menu when the frequency indication is selected.

- 3 Select "Set Preset", then press (+).**
- 4 Select a preset number, then press (+).**
The station is stored as the selected preset number.

- 5 Repeat steps 1 to 4 to store another station.**

You can store station as follows:

- AM band: AM 1 to AM 30
- FM band: FM 1 to FM 30

Tuning to preset stations

- 1 Select "Listen" from the home menu, then press (+).**
- 2 Select "FM/AM", then press (+).**
- 3 Select the preset number from the list, then press (+).**
Preset numbers from 1 to 30 are available.

To name preset stations (Name Input)

- 1 Select the preset number on which you want to name.**
- 2 Press OPTIONS.**
The options menu appears.
- 3 Select "Name Input", then press (+).**
The on-screen keyboard appears on the TV screen.
- 4 Press ↑/↓/←/→ and (+) to select a character one by one to enter the name.**
- 5 Select "Enter", then press (+).**
The name you entered is registered.

Note

Some letters that can be displayed on the TV screen cannot be displayed on the display panel.

To cancel naming input

Press RETURN ↶.

Selecting the sound field

- 1 Select “Sound Effect” from the home menu, then press (+).
- 2 Select “Sound Field” then press (+).
- 3 Select the sound field you want.

Tips

- You can press SOUND FIELD +/- on the remote control repeatedly to select the sound field you want.
- You can also use A.F.D./2CH, MOVIE or MUSIC on the receiver.

Auto Format Direct (A.F.D.)/2 channel sound mode

- **Auto Format Direct (A.F.D.) mode:** This mode allows you to listen to higher fidelity sound and select the decoding mode for listening to a 2 channel stereo or monaural sound as multi channel sound.
- **2 channel sound mode:** You can switch the output sound to 2 channel sound regardless of the recording formats of the software you are using, the playback equipment connected, or the sound field settings of the receiver.

■ A.F.D. Auto (A.F.D. AUTO)

Presets the sound as it was recorded/encoded without adding any surround effects.

However, for USA and Canada models, this receiver will generate a low frequency signal for output to the subwoofer when there is no LFE signals.

■ Multi Stereo (MULTI ST.)

Outputs 2 channel left/right or monaural signals from all speakers. However, sound may not be output from certain speakers depending on the speaker settings.

■ 2ch Stereo (2CH ST.)

The receiver outputs the sound from the front left/right speakers only. There is no sound from the subwoofer.

Standard 2 channel stereo sources completely bypass the sound field processing and multi channel surround formats are downmixed to 2 channels.

■ 2ch Analog Direct (A. DIRECT)

You can switch the audio of the selected input to 2 channel analog input. This function enables you to enjoy high quality analog sources.

When using this function, only the volume and front speaker level can be adjusted.

Note

You cannot select “2ch Analog Direct” while using the BD, DVD, GAME, VIDEO 2, VIDEO 3, *Bluetooth*, USB, Home Network, SEN, and AirPlay function.

Movie mode

You can take advantage of surround sound simply by selecting one of the receiver’s pre-programmed sound fields. They bring the exciting and powerful sound of movie theaters into your home.

■ HD-D.C.S.

HD Digital Cinema Sound (HD-D.C.S.) is Sony’s new innovative home theater technology using the latest acoustic and digital signal processing technologies. It is based on precise response measurement data of a mastering studio.

With this mode, you are able to enjoy Blu-ray and DVD movies at home with not only the high quality of sound, but also the best sound ambience, just as the movie's sound engineer intended in the mastering process.

- **Dynamic:** This setting is suitable for an environment which is reverberant but lacks a spacious feeling (where sound absorption is not sufficient). It emphasizes the reflection of sound and reproduces the sound of a large, classical movie theater. Thus, the spacious feeling of a dubbing theater is emphasized and a unique acoustic field is created.
- **Theater:** This setting is suitable for a general living room. It reproduces the reverberation of sound just like in a movie theater (dubbing theater). It is most appropriate for watching content recorded on a Blu-ray Disc when you want the atmosphere of a movie theater.
- **Studio:** This setting is suitable for a living room with the appropriate sound equipment. It reproduces the reverberation of sound provided when a theatrical sound source is remixed for a Blu-ray Disc to a volume level suitable for home use. The level of reflection and reverberation of sound is kept to the minimum. However, dialogues and surround effects are reproduced vividly.

■ PLII Movie

Performs Dolby Pro Logic II Movie mode decoding. This setting is ideal for movies encoded in Dolby Surround. In addition, this mode can reproduce sound in 5.1 channel for watching videos of overdubbed or old movies.

■ PLIIx Movie

Performs Dolby Pro Logic IIx Movie mode decoding. This setting expands Dolby Pro Logic II Movie or Dolby Digital 5.1 to discrete 7.1 movie channels.

■ PLIIz Movie (PLIIz)

Performs Dolby Pro Logic IIz mode decoding. This setting can expand a source sound from a 5.1 channel to a 7.1 channel to which a vertical equipment is applied, and gives a dimension of presence and depth.

■ Neo:6 Cinema (Neo:6 CIN)

Performs DTS Neo:6 Cinema mode decoding. A source recorded in 2 channel format is decoded into 7 channels.

Music mode

You can take advantage of surround sound simply by selecting one of the receiver's pre-programmed sound fields. They bring the exciting and powerful sound of concert halls into your home.

■ Berlin Philharmonic Hall (BERLIN)

Reproduces the sound characteristics of the Berlin Philharmonic Hall.

■ Concertgebouw Amsterdam (CONCERTGEB)

Reproduces the sound characteristics produced by reflectivity of a concert hall in Amsterdam, Netherlands, which features a large sound stage.

■ Musikverein Vienna (MUSIKVEREI)

Reproduces the sound characteristics of a concert hall in Vienna, Austria, which features a resonant and unique reverberative sound.

■ Jazz Club (JAZZ)

Reproduces the acoustics of a jazz club.

■ Live Concert (CONCERT)

Reproduces the acoustics of a 300-seat live house.

■ Stadium (STADIUM)

Reproduces the feeling of a large open-air stadium.

■ Sports (SPORTS)

Reproduces the feeling of sports broadcasting.

■ Portable Audio (PORTABLE)

Reproduces a clear enhanced sound image from your portable audio device. This mode is ideal for MP3 and other compressed music.

■ PLII Music

Performs Dolby Pro Logic II Music mode decoding. This setting is ideal for normal stereo sources such as CDs.

■ PLIIx Music

Performs Dolby Pro Logic IIx Music mode decoding. This setting is ideal for normal stereo sources such as CDs.

■ PLIIz Music (PLIIz)

Performs Dolby Pro Logic IIz mode decoding. This setting can expand a source sound from a 5.1 channel to a 7.1 channel to which a vertical equipment is applied, and gives a dimension of presence and depth.

■ Neo:6 Music (Neo:6 MUS)

Performs DTS Neo:6 Music mode decoding. A source recorded in 2 channel format is decoded into 7 channels. This setting is ideal for normal stereo sources such as CDs.

When headphones are connected

You can only select this sound field if the headphones are connected to the receiver.

■ Headphone (2ch) (HP 2CH)

This mode is selected automatically if you use headphones (except “2ch Analog Direct”). Standard 2 channel stereo sources completely bypass the sound field processing and multi channel surround formats are downmixed to 2 channels except LFE signals.

■ Headphone (Direct) (HP DIRECT)

This mode is selected automatically if you use headphones when “2ch Analog Direct” is selected.

Outputs the analog signals without processing by the equalizer, sound field, etc.

If you connect a subwoofer

This receiver will generate a low frequency signal for output to the subwoofer when there is no LFE signal, which is a low-pass sound effect output from a subwoofer to a 2 channel signal. However, the low frequency signal is not generated for “Neo:6 Cinema” or “Neo:6 Music” when all speakers are set to “Large”. In order to take full advantage of the Dolby Digital bass redirection circuitry, we recommend setting the subwoofer’s cut off frequency as high as possible.

Notes on sound fields

- Depending on the speaker pattern settings, some sound fields may not be available.
- You cannot select “PLIIx Movie”, “PLIIx Music”, “PLIIz Movie”, and “PLIIz Music” at the same time.

- “PLIIX Movie” and “PLIIX Music” are available only when the speaker pattern is set to a setting with surround back speaker(s).
- “PLIIZ Movie” and “PLIIZ Music” are available only when the speaker pattern is set to a setting with front high speakers.
- The sound fields for music and movie do not work in the following cases.
 - DTS-HD Master Audio, DTS-HD High Resolution Audio or Dolby TrueHD with sampling frequency of more than 48 kHz are being received.
 - “2ch Analog Direct” is selected.
- “PLII Movie”, “PLII Music”, “PLIIX Movie”, “PLIIX Music”, “PLIIZ Movie”, “PLIIZ Music”, “Neo:6 Cinema” and “Neo:6 Music” do not work when the speaker pattern is set to 2/0 or 2/0.1.
- When one of the sound fields for music is selected, no sound is output from the subwoofer if all the speakers are set to “Large” in the Speaker Settings menu. However, the sound will be output from the subwoofer if
 - the digital input signal contains LFE signals.
 - the front or surround speakers are set to “Small”.
 - “Multi Stereo”, “PLII Movie”, “PLII Music”, “PLIIX Movie”, “PLIIX Music”, “PLIIZ Movie”, “PLIIZ Music”, “HD-D.C.S.” or “Portable Audio” is selected.

Adjusting the equalizer

You can use the following parameters to adjust the tonal quality (bass/treble level) of front, center, surround/surround back and front high speakers.

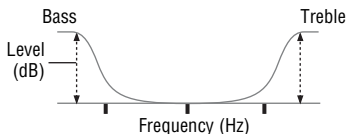

- 1** Select “Sound Effects” from the home menu, then press **+**.
- 2** Select “Equalizer”, then press **+**.
- 3** Select “Front”, “Center”, “SUR/SB”, or “Front High”, then press **+**.
- 4** Select “Bass” or “Treble”, then adjust the gain.

Notes

- This function does not work when “2ch Analog Direct” is being used.
- Frequencies for Bass and Treble are fixed.
- Depending on the audio format, the receiver may play back signals at a lower sampling frequency than the original sampling frequency of the input signals.

Using the Sound Optimizer function

The Sound Optimizer lets you enjoy clear and dynamic sound at low volume levels. It automatically calibrates the sound which cannot be heard well when you turn down the volume level. After Auto Calibration is performed, the sound level is optimized to suit your environment.

- 1** Select “Sound Effects” from the home menu, then press \oplus .
- 2** Select “Sound Optimizer”, then press \oplus .
- 3** Select “Normal” or “Low”, then press \oplus .

The Sound Optimizer function is activated. To adjust for the reference level of a movie, select “Normal”. To adjust for a CD or other software whose average sound pressure level is processed highly, select “Low”.

Notes

- This function does not work in the following cases.
 - “2ch Analog Direct” is being used.
 - Headphones are connected.
- The receiver may play back signals at a lower sampling frequency than the actual sampling frequency of the input signals, depending on the audio format.

Selecting the calibration type

You can select the calibration type you want after performing the Auto Calibration. For details, see “Auto Calibration Type” (page 95).

Using the Pure Direct function

The Pure Direct mode lets you enjoy higher fidelity sound. When Pure Direct is on, the display panel lights off to suppress noise that affects sound quality. You can use the Pure Direct function with all inputs.

- 1** Select “Sound Effects” from the home menu, then press \oplus .
- 2** Select “Pure Direct”, then press \oplus .
- 3** Select “On”, then press \oplus .

Note

When Pure Direct function is selected, “Equalizer”, “Sound Optimizer”, “Advanced Auto Volume” and “Dynamic Range Compressor” do not work.

Tip

You can also use PURE DIRECT button on the remote control or receiver to turn on or off the Pure Direct function.

To cancel Pure Direct

The Pure Direct function will be canceled when you perform the following:

- Select “Off” in step 3 in “Using the Pure Direct function” (page 59).
- Press PURE DIRECT again.
- Change the sound field.
- Change the scene setting on the TV (Scene Select).
- Change the setting of “Equalizer”, “Sound Optimizer”, “Advanced Auto Volume” or “Dynamic Range Compressor”.

Resetting sound fields to the default settings

Be sure to use the buttons on the receiver to perform this operation.

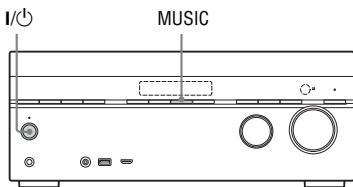

- 1 Press I/⏻ to turn off the receiver.**
- 2 While holding down MUSIC, press I/⏻.**

“S.F. CLEAR” appears on the display panel and all sound fields are reset to their default setting.

Using Network Features

About the network functions of the receiver

- You can enjoy audio content which has been stored on a DLNA-compliant device (DLNA CERTIFIED™ Products) that has an authorized DLNA logo displayed on the device (page 66).
- You can use the receiver as a device equivalent to a UPnP media renderer on your home network.
- With an Internet connection, you can listen to music services (page 70) and update the software of the receiver (page 75).
- You can listen to the same music at the same time in different rooms through the PARTY STREAMING function.
- You can register TV SideView devices to control the receiver.
- You can play back audio content on iOS devices or an iTunes Library with AirPlay.

About DLNA

DLNA (Digital Living Network Alliance) is a standard organization made up of manufacturers of various products, such as servers (computers, etc.), AV equipment, and mobile computing devices which exchange content (music, photos, and videos). DLNA decides upon standards and publishes an authorized logo to be displayed on devices which support DLNA standards.

Setting up the server

To listen to audio content stored on your server with this receiver, you need to set up the server in advance. The following server devices are compatible with this receiver.

- Sony VAIO Media plus 1.3, 1.4, 2.0, and 2.1
- Sony HDD Network Audio System NAS-S500HDE*, NAS-S55HDE*
- Sony Network AV receiver STR-DA6400ES*, TA-DA5600ES*
- Microsoft Windows Media Player 12 installed on Windows 8 and Windows 7 (page 61, 63)
- Microsoft Windows Media Player 11 installed on Windows Vista/Windows XP (page 64)

* Not available in some countries or regions.

If the server has a function that limits access from other devices, you must change the setting on the server to allow the receiver to access it.

This section explains how to set up Windows Media Player when using it as a server.

For details on the settings of other server devices, refer to the operating instructions or help of the respective devices or applications.

Notes

- The items displayed on the computer may be different from the ones shown below, depending on the version of the operating system or the computer environment. For details, refer to Help for your operating system.
- It may take a little more time when playing music using a “Play To” feature in Windows depending on the situation.

When using Windows 8

This section explains how to set up manufacturer-installed Windows Media Player 12 for Windows 8. For details on how to operate Windows Media Player 12, refer to Help for Windows Media Player 12.

- 1 **Go to Control Panel.**
Select [All Apps] under [Start].
Select [Control Panel].

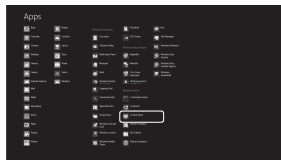

Tip

If the Windows 8 display does not appear like above, proceed with the steps below.

3 Select [Control Panel] under [Settings].



2 Select [View network status and tasks] under [Network and Internet].

The [Network and Sharing Center] window appears.

Tip

If the item you want does not appear on the display, try to change the display type of the Control Panel.

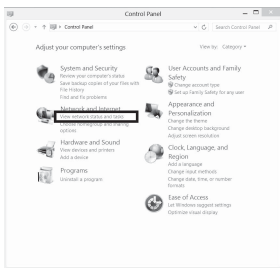

3 Select [Change advanced sharing settings].

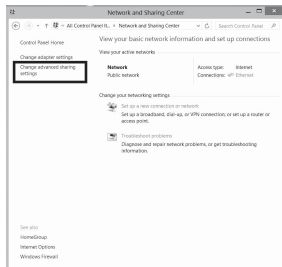

4 Select [Choose media streaming options] from Media streaming.

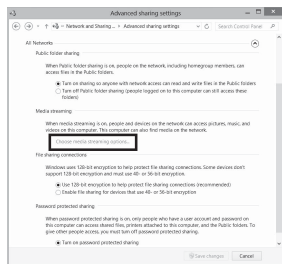

5 If [Media streaming is not turned on] appears on the [Media streaming options] window, select [Turn on media streaming].

6 Select **[Allow All]**.

The [Allow All Media Devices] window opens.

If all the devices in the local network are set to [Allowed], select **[OK]** and close the window.

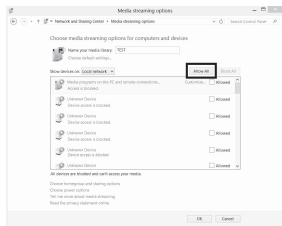
**7** Select **[Allow all computers and media devices]**.**8** Select **[OK]** to close the window.**9** Refresh the server list.

When the settings are completed, refresh the server list of the receiver and select this server from the server list. For details on selecting a server, see “To refresh the server list” (page 66).

When using Windows 7

This section explains how to set up manufacturer-installed Windows Media Player 12 for Windows 7.

For details on how to operate Windows Media Player 12, refer to Help for Windows Media Player 12.

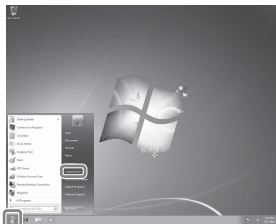
1 Go to **[Start] – [Control Panel]**.**2** Select **[View network status and tasks]** under **[Network and Internet]**.

The [Network and Sharing Center] window appears.

Tip

If the item you want does not appear on the display, try to change the display type of the Control Panel.

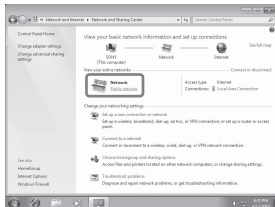
3 Select **[Public network]** under **[View your active networks]**.
If the display shows other than [Public Network], go to step 6.
The [Set Network Location] window appears.

4 Select [Home network] or [Work network] according to the environment in which the receiver is used.

5 Follow the instructions that appear on the display according to the environment in which the receiver is used.

When the settings are completed, confirm that the item under [View your active networks] is changed to [Home network] or [Work network] in the [Network and Sharing Center] window.

6 Select [Change advanced sharing settings].

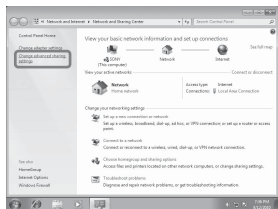

7 Select [Choose media streaming options...] from [Media streaming].

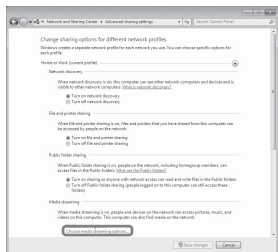

8 If [Media streaming is not turned on] appears on the [Media streaming options] window, select [Turn on media streaming].

9 Select [Allow all].

The [Allow All Media Devices] window opens. If all the devices in the local network are set to [Allowed], select [OK] and close the window.

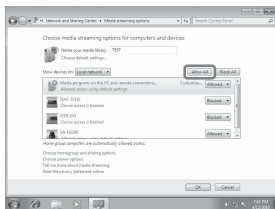

10 Select [Allow all computers and media devices].

11 Select [OK] to close the window.

12 Refresh the server list.

After you finish setting up Windows Media Player 12, refresh the server list of the receiver and select this server from the server list. For details on selecting a server, see “To refresh the server list” (page 66).

When using Windows Vista/XP

This section explains how to set up Windows Media Player 11 installed on Windows Vista/XP*.

For details on how to operate Windows Media Player 11, refer to Help for Windows Media Player 11.

* Windows Media Player 11 is not manufacturer-installed on Windows XP. Access the Microsoft website, download the installer, and then install Windows Media Player 11 on your computer.

1 Go to [Start] – [All Programs].



2 Select [Windows Media Player].

Windows Media Player 11 starts up.

3 Select [Media Sharing...] from the [Library] menu.

If you are using Windows XP, go to step 9.

4 When is displayed, select [Networking...].

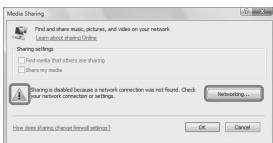

The [Network and Sharing Center] window appears.

5 Select [Customize].

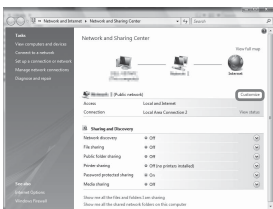

The [Set Network Location] window appears.

6 Check [Private] and select [Next].

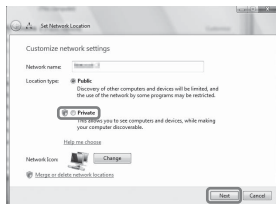

7 Confirm that [Location type] is changed to [Private], and select [Close].

8 Confirm that [(Private network)] is displayed on the [Network and Sharing Center] window, and close the window.

9 If [Share my media] in the [Media Sharing] window that is displayed in step 3 is not checked, check [Share my media], then select [OK].

A list of connectable devices is displayed.

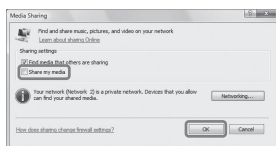

10 Select [Settings...] that appears beside [Share my media to:].

11 Check [Allow new devices and computers automatically] and select [OK].

Note

Uncheck this item after you confirm that the receiver can be connected to the server and play audio content stored on the server.

12 Refresh the server list.

After you finish setting up Windows Media Player 11, refresh the server list of the receiver and select this server from the server list. For details on selecting a server, see “To refresh the server list” (page 66).

To refresh the server list

When you add a new server to the home network, or when you cannot find the server you want on the list, refresh the server list.

- 1 While the server list is displayed, press **OPTIONS**.
- 2 Select “Refresh”, then press **(+)**.
The refreshed server list appears.

Tip

The receiver keeps a history of the last five connected servers and these servers appear at the top of the server list. Up to 20 servers can be displayed in a server list.

To delete a server from the server list

- 1 While the server list is displayed, select the server you want to delete, then press **OPTIONS**.
The options menu appears.
- 2 Select “Delete”, then press **(+)**.
The confirmation display appears on the TV screen.
- 3 Select “OK”, then press **(+)**.
“Complete!” appears, and the selected server is deleted.

Note

Even if you delete the server from the server list, the server will appear in the list again if the receiver finds it on the network (such as when you refresh the server list).

Enjoying audio content stored on the server

You can play back audio content stored on the server using the receiver in MP3, Linear PCM, WMA, FLAC and AAC* formats. Audio content with DRM (Digital Rights Management) copyright protection cannot be played on this receiver.

* The receiver can play AAC files with the extension of “.m4a”, “.mp4” or “.3gp” only.

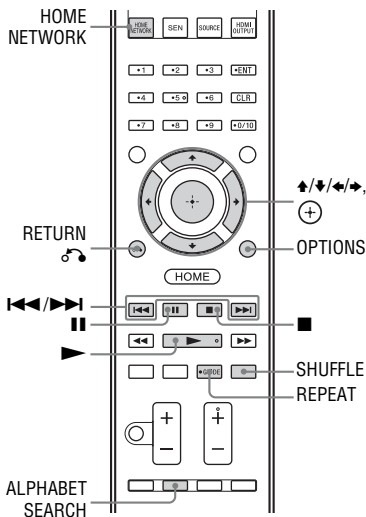
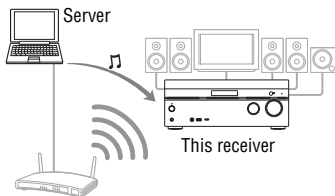

1 Press HOME NETWORK.

The server list appears on the TV screen.

If the last selected item (playlist, album, folder, etc.) appears on the TV screen, press RETURN  repeatedly until the server list appears.

When “No server is available” appears, or when the server on the list is not available, press OPTIONS. Select “Refresh”, then press . The refreshed server list appears.

Tip

You can also select “Home Network” from “Listen” in home menu.

2 Select the DLNA server icon, then press .

The content list appears on the TV screen.

Note

If the server device supports the Wake-on-LAN standard, the receiver turns the server on automatically. If the server does not support the Wake-on-LAN standard, turn on the server in advance. For details on settings or operations of Wake-on-LAN of your server, refer to the operating instructions or help of your server.

3 Select the item (playlist, album, folder, etc.) you want, then press .

If another item appears, repeat this step to narrow down the choices until the item you want appears. The items that are displayed depend on the connected server.

4 Select the track you want, then press .

Playback starts.

Make sure that sound is being output from the speakers of the receiver.

Notes

- Tracks that the receiver cannot play appear on the TV screen as well. You cannot sort a list of playable tracks.

- Play is not resumed from the last selected item if you unplug the AC power cord (mains lead) from the wall outlet.
- The receiver may take time to display items when browsing a folder that contains a large amount of audio content. In this case, use the Keyword Search (page 77).

Tips



- If you select a folder (such as an artist folder, genre folder, etc.), then press the  button, the receiver plays all items in the selected folder.
- The receiver resumes from the last selected item when the function is changed to Home Network function, until the receiver is turned off. When “Network Standby” is set to “On”, play resumes from the last selected item, even if you turned off the receiver.

To set Access Settings

You can set access restrictions or permission for the devices on the device list.

1 Press HOME NETWORK.**Tip**

You can also select “Home Network” from “Listen” in home menu.

2 Press OPTIONS.**3 Select “Access Settings”, then press .****To set the auto access permission****1 Select “Auto Access” in “Access Settings”, then press .****2 Select “Allow” or “Not Allow”, then press .**

- **Allow:** All the device on the home network are permitted to access this receiver. This receiver can start a PARTY as host device and join a PARTY as a guest device if requested.

- **Not Allow:** The receiver restricts a new device that is accessing the receiver. When connecting a new device to the home network, add the device to the device list, and set access permission (page 68).

Note

Up to 20 devices can be added to the device list. If 20 devices have already been registered, “Device Full” appears, and a new device cannot be added to the list. In this case, delete unnecessary devices from the list (page 68).

To add devices to the device list

- 1 Select “Control Device” in “Access Settings”, then press (+).
The registered device list appears on the TV screen.
- 2 Select “Add Device”, then press (+).
- 3 Select the device you want, then press (+).
The selected device is added to the device list. For details on setting the access, see “To set access permission for the devices” (page 68).

To set access permission for the devices

You can set access permission for a device on the device list. Only devices set to “Allow” are recognized on the home network.

- 1 Select “Control Device” in “Access Settings”, then press (+).
The registered device list appears on the TV screen.
- 2 Select the device you want, then press (+).
- 3 Select “Access”, then press (+).
- 4 Select “Allow” or “Not Allow”, then press (+).

To delete a device from the list

Select “Delete” in step 3 in “To set access permission for the devices” (page 68), then press (+).
Select “OK” on the confirmation display, then press (+).

Using the TV SideView

TV SideView is a free mobile application for the remote device (smartphone, etc). By using the TV SideView with this receiver, you can easily enjoy the receiver by the operation on your remote device.

To register the TV SideView Device

- 1 Press HOME NETWORK.

Tip

You can also select “Home Network” from “Listen” in home menu.

- 2 Press OPTIONS.
- 3 Select “TV SideView Device Registration”, then press (+).
- 4 Select “Start Registration”, then press (+).

The receiver starts to detect TV SideView device that is ready for registration.

“Connecting” appears on the TV screen. Press “Registration” on the TV SideView device. However, the receiver will exit the registration if no device detected in 30 seconds.

- 5 Select “Finish”, then press (+).

To cancel the registration

Select “Cancel” in step 4, then press (+).

Note

Up to 5 TV SideView devices can be added to the device list. If 5 devices have already been registered, “Device Full” appears, and a new device cannot be added to the list. In this case, delete unnecessary devices from the list (page 69).

To view the registered TV SideView Device

Select “Registered TV SideView Devices” in step 3, then press **(+)**.

To delete registered TV SideView devices from the device list

- 1 Select “Registered TV SideView Devices” in step 3, then press **(+)**.
- 2 Select the device you want to delete, then press **(+)**.
- 3 Select “Delete”, then press **(+)**.
- 4 Select “OK”, then press **(+)**.

The selected device is deleted from the device list.

To check the copyright protection

This receiver cannot play back files in WMA format with DRM copyright protection.

If a WMA file cannot be played back on this receiver, check the property of that file on your computer to see whether the file is DRM-copyrighted.

Open the folder or volume where the WMA file is stored and right-click the file to display the [Properties] window. If there is a [License] tab, the file is DRM-copyrighted and cannot be played back on this receiver.

To operate Home Network function using the remote control

To	Do the following
Pause playback*	Press during playback. Press ▶ to resume playback.
Stop playback	Press ■ .
Go to beginning of the current track, previous/next track	Press ◀◀/▶▶ repeatedly.

To	Do the following
Reselect the item you want to play	Press RETURN ↵ repeatedly until the directory you want appears. Or press OPTIONS, select “Server List”, then select the item you want. To return to the playback display, press OPTIONS and select “Now Playing”.
Search the item you want using a keyword	While selecting the contents in the server, press ALPHABET SEARCH, and then enter a keyword (page 77).
Change the server	While playback is stopped, press OPTIONS. Select “Server List”, then press (+) . Select the server you want, then press (+) .
Select Repeat Play	Press REPEAT repeatedly until “Repeat All” or “Repeat 1” appears on the TV screen.
Select Shuffle Play	Press SHUFFLE repeatedly until “Shuffle On” appears on the TV screen.

* Depending on the server or track, pause playback may not work when the Home Network function is selected.

Enjoying Sony Entertainment Network (SEN)

You can listen to music services offered on the Internet with this receiver (SEN function).

To use this function, the receiver must be connected to the network and the network must be connected to the Internet. For details, see “6: Connecting to the network” (page 35).

Visit the website below for more information on the SEN:

<http://www.sonyentertainmentnetwork.com>

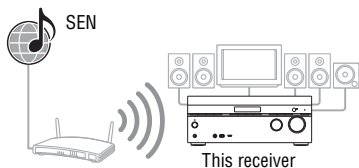

Note

Before using music services, you may have to register your receiver depending on the service provider. For details on registration, visit the customer support site of the service provider.

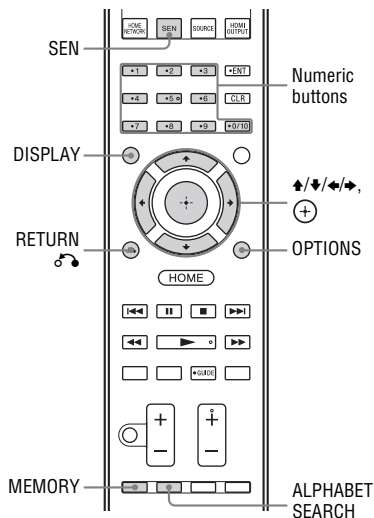

The following steps explain how to select “vTuner” as an example of music services offered on the Internet.

1 Press SEN.

The service provider list appears on the TV screen. If the receiver automatically displays the last selected service or station, press RETURN repeatedly until the service provider list appears.

Tip

You can also select “SEN” from “Listen” in home menu.

2 Select “vTuner”, then press (+).

3 Select the folder or station you want, then press (+).

- Press \uparrow/\downarrow repeatedly to select the item.
- Press (+) to go to the next directory, or to listen to the station.
- Press RETURN to go to the previous directory.



Note

If “No service is available” appears and you cannot obtain a service provider list, press **OPTIONS** and select “Refresh”.

Tip

The receiver displays the last selected service or station when the function is changed to **SEN** function, until the receiver is turned off. When “Network Standby” is set to “On”, the last selected service or station is displayed even if you turned off the receiver.

To operate **SEN** function using the remote control

To	Do the following
Change the station or service	Press RETURN  to return to the service provider list, then select the service again. To return to the playback display again, press OPTIONS and select “Now Playing”.
Use various functions while the receiver is selecting or playing a station or service	Press OPTIONS . The item displayed may vary according to the selected item or directory.
Select the service options	While selecting or playing the contents in the service, press OPTIONS . Select “Service Options”, then press  . The contents of the service options vary depending on the selected services.
Search the item you want using a keyword	While selecting the contents in the server, press ALPHABET SEARCH , and then enter a keyword (page 77).
View the available information	Press DISPLAY repeatedly to view the artist name, album name, etc.

Presetting stations

You can store up to 20 stations as your favorite stations.

- 1 Select the station you want to preset.
- 2 During reception, press **MEMORY**. The preset memory list appears.
- 3 Select a preset number, then press .
- 4 Repeat steps 1 to 3 to store another station.



To listen to the preset station

- 1 Press **SEN**.

The service provider list appears on the TV screen. If the receiver automatically displays the last selected station, press **RETURN**  repeatedly until the service provider list appears.

Tip

You can also select “SEN” from “Listen” in home menu.

- 2 Select “Preset”, then press .
- 3 Select the preset station you want, then press .

Note

There may be some stations that cannot be preset, depending on the service providers. If you try to preset such a station, “Not available” appears on the display.

Enjoying a variety of music services

You can enjoy listening to the content of a variety of music services offered on the Internet.

Visit the website below for more information on music services, how to enjoy services, and the registration code of the receiver.

<http://munlimited.com/home>

Checking the registration code

You may be required to enter the registration code of the receiver when you enjoy a new music service.

1 Press SEN.

The service provider list appears on the TV screen. If the receiver automatically displays the last selected service or station, press RETURN  repeatedly until the service provider list appears.

Tip

You can also select “SEN” from “Listen” in home menu.

2 Select “Registration Code”, then press .

The registration code of the receiver appears.

Using the PARTY STREAMING function

Audio contents currently being played back on this receiver can be also played back on all devices corresponding to the PARTY STREAMING function on your home network at the same time.

If you encounter an interruption when using a wireless connection, connect your receiver to the router with a wired connection (page 36).

While PARTY streaming, a device called a “PARTY host” starts a PARTY and streams music, and a device called a “PARTY guest” joins a PARTY and receives music from the “PARTY host”. Before using the PARTY STREAMING function, make sure that “PARTY STREAMING” is set to “On” (page 101).

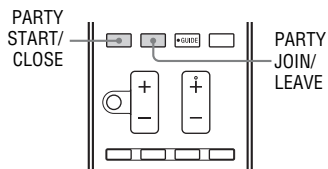
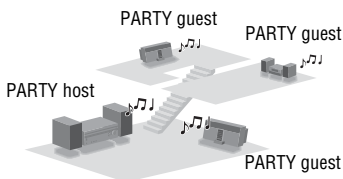

You can enjoy the PARTY STREAMING function with other devices* that have this PARTY STREAMING logo shown below.



* Available PARTY STREAMING-compliant devices may differ depending on the countries or regions. For details on available devices, contact your nearest Sony dealers.

Starting a PARTY

You can start a PARTY so that other devices that support the PARTY STREAMING function can play the same music even though they are in different rooms.

1 Make sure the PARTY guest devices are turned on and ready to join a PARTY.

2 Play the sound source you want.
Audio content of all the sound sources on this receiver can be streamed.

Notes

- Only audio contents on this receiver can be streamed. During PARTY host, video signals are not output to the TV, and audio signals will downmix to 2 channel. In this case, you can only select “2ch Stereo” as sound field.
- When you start a PARTY as PARTY host, you may face a time gap between the audio output and visual display in the following cases.
 - The Audio Return Channel (ARC) function is used.
 - The video output of the equipment is connected to the TV and the audio output is connected to the digital or analog audio input jacks on the receiver.
- Sources with copyright protection may not be streamed.

3 Press PARTY START.

“START PARTY” appears on the display panel.
The receiver starts PARTY streaming as a PARTY host.

To close a PARTY

Press PARTY CLOSE.
“CLOSE PARTY” appears on the display panel.

Joining a PARTY

The receiver can join a PARTY that has been started by another device so that you can enjoy the same audio content being played in a different room.

While the PARTY host device is having a PARTY, press PARTY JOIN.
“JOIN PARTY” appears, and the receiver joins the PARTY as a PARTY guest.

To leave a PARTY

Press PARTY LEAVE.

“LEAVE PARTY” appears, and the receiver leaves a PARTY.

Notes

- You cannot join a PARTY in the following cases:
 - you have a PARTY on this receiver.
 - you have already joined another PARTY.
- If you press PARTY JOIN when no PARTY is started, but a device complying with PARTY STREAMING function is playing, the device will be the PARTY host, and the receiver will join the PARTY as a PARTY guest.
- The PARTY guest device function automatically switches to HOME NETWORK when the device joins a PARTY. Even if the PARTY guest device leaves the PARTY, the function remains as HOME NETWORK.

Tip

If “Network Standby” is set to “On”, the receiver turns on and joins the PARTY automatically when the PARTY host device starts the PARTY.

Streaming music from iTunes with AirPlay

Using a wireless network, you can play back audio content on iOS devices such as an iPhone, iPod touch, iPad or an iTunes Library on your PC with this receiver.

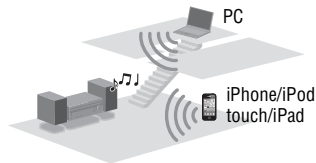

Compatible iPod/iPhone/iPad models

iPhone 4S, iPhone 4, iPhone 3GS, iPod touch (2nd, 3rd or 4th generation), iPad, iPad2, iPad 3rd generation with iOS 4.2 or later, and Mac or PC with iTunes 10.1 or later.

Notes

- Refer to “Compatible iPod/iPhone/iPad models” on this page for details on the supported versions of iOS or iTunes.
- Update iOS or iTunes to the latest version before using with the receiver.
- Refer to the operating instructions of your device for details on operating iOS devices, iTunes or AirPlay.
- You cannot use this receiver as a PARTY host while using the AirPlay function.

- 1 Tap/click on the  icon at bottom right of the iOS device screen or iTunes window.**

[iOS device]

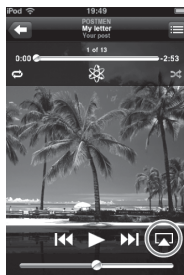

[iTunes]

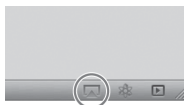

- 2 Select “STR-DN1040” on the AirPlay menu of iTunes or your iOS device.**

[iOS device]

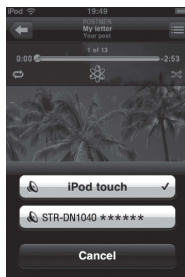

[iTunes]

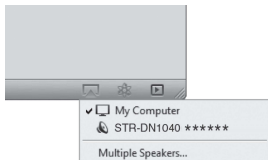

- 3 Start playing back audio content on an iOS device or on iTunes.**

AirPlay is selected as a function of the receiver automatically.





Tips

- “*****” is the last 6 digits of MAC Address of the receiver.
- If the playback does not start, perform the process again from step 1.

To confirm/edit the device name

See “Device Name” (page 101) for instructions on how to rename the device.

To control AirPlay playback

You can use the  +/-, , , , , SHUFFLE and REPEAT buttons. Operation from the receiver and the remote control is active only when the receiver is selected as the device for output.

When you use iTunes, set an iOS device to accept control from this receiver and the remote control when you want to use this receiver and the remote control to operate an iOS device.

Tips

- The most recent control command to the receiver is given priority. The receiver starts playing back audio content of another device when it accepts control from that AirPlay-equipped device, even if this receiver is being used for AirPlay with the original device.
- The very loud sound may output from this receiver when you set the volume too loud using iOS devices or iTunes.
- For details on the use of iTunes, refer to the Help of iTunes.
- The volume level of iOS devices or iTunes may not be able to be linked with the volume level of this receiver.

Updating the software

By downloading the latest version of the software, you can take advantage of the newest functions. The receiver accesses the Sony server to update the software.

If a new update is available, follow the on-screen instructions to update the software. "UPDATE" appears on the display panel when you are connected to the Internet and using the Home Network or SEN function. Make sure that other equipment connected to the receiver is stopped before updating the software.

For details on software update available, refer to the customer support site (page 127).

Notes

- Make sure not to turn off the receiver, disconnect the network cable or perform any operation on the receiver while the updating operation is in progress.
- If you try to update the software when the Sleep Timer is on, the Sleep Timer will turn off automatically.

- 1 Select "Settings" from the home menu, then press \oplus .**

The Settings menu list appears on the TV screen.

- 2 Select "System", then press \oplus .**

- 3 Select "Network Update", then press \oplus .**

- 4 Select "Start", then press \oplus .**

The receiver starts checking the available software update. Once you start the update, you cannot restore the previous software version.

The receiver completes the software download when "Download 100%" appears on the TV screen. Then, the receiver starts to update the software. The GUI and display panel are turned off automatically and the I/⏻ (on/standby) indicator on the front panel flashes slowly. It may take about 40 minutes to several hours at the longest for the update to complete. The time required for the update varies depending on the update conditions, such as the speed of the Internet connection, etc.

When the update is completed, "COMPLETE" appears on the display panel and the receiver will restart automatically.

Note

When the I/⏻ (on/standby) indicator on the front panel flashes slowly, do not disconnect the AC power cord (mains lead).

To cancel the procedure

Select "Cancel" in step 4.

To go back to the previous screen

Press RETURN \curvearrowright before the receiver starts the software update.

You cannot go back to the previous screen when the update starts.

Network features message list

Network settings

Message and explanation

Invalid ■■■■*

The entered values are incorrect or invalid.

* ■■■■ represent a SSID, IP Address, Security Key, Subnet Mask, Default Gateway, Primary DNS, and Secondary DNS.

■■■■ may be different depending on the network setup.

Home Network

Message and explanation

Cannot connect

The receiver cannot be connected to the selected server.

Cannot get info

The receiver cannot retrieve information on the server or contents.

Cannot JOIN

The receiver has failed to join a PARTY.

Cannot play

The receiver cannot play audio files due to an unsupported file format or playback restrictions.

Cannot START

The receiver has failed to start a PARTY.

Data Error

You tried to play an unplayable file.

Device Full!

You cannot register any more devices to the device list.

Initialize

The receiver is performing a factory default setting to Network function.

No server is available

There is no server on the network that the receiver can connect to. Try refreshing the server list (page 66).

No Track

There is no playable file in the selected folder on the server.

Message and explanation

Not Found

There is no item on the server that matches a keyword.

Not in Use

An operation that is currently prohibited is being performed.

SEN

Message and explanation

Cannot connect

The receiver cannot be connected to the selected server.

Cannot get info

The receiver cannot obtain content from the server.

Cannot play

- You tried to play an unplayable file.
- The receiver cannot play a service or station due to an unsupported file format or playback restrictions.

Software update is required

The service is not available in the current version of the receiver software. Visit the website below for more information on the software update:

<http://munlimited.com/home>

No Preset

There is no station stored on the receiver for the selected preset number.

No service is available

There is no service provider.

No Stations Available

There is no station in the selected service.

Not available

- The selected service is not available.
- An operation that is currently unavailable is being performed.

Not in Use

An operation that is currently prohibited is being performed.

Searching for an item using a keyword

When a list is displayed on the TV screen (such as artist list, a track list, etc.), you can enter a keyword to search for an item you want.

Searching by keywords is available only when the Home Network or SEN function is selected.

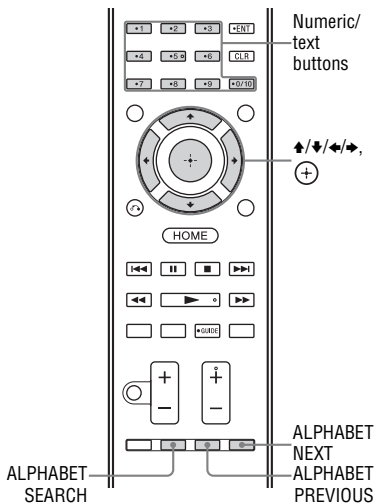

- 1 Press ALPHABET SEARCH while an item list (artist list, track list, etc.) is displayed on the TV screen.**
The keyword input display appears on the TV screen.
- 2 Press the numeric/text buttons to enter a keyword.**
A keyword can be up to 15 characters.

Note

Enter a keyword that will match the letters or a word at the beginning of the name or title of the item you want to search for. When the receiver searches for an item, "The" at the beginning of a name and the following space will be ignored.

- 3 Press (+).**
An item that matches the keyword appears. If the item appears is not the one you are searching for, press ALPHABET PREVIOUS/ALPHABET NEXT to display the previous/next item.
- 4 Repeat steps 1 to 3 until you find the item you want, then press (+).**
- 5 Select the track you want, then press (+).**
Playback starts.

Using *Bluetooth* Features

About the *Bluetooth* wireless technology

Bluetooth wireless technology is a short-range wireless technology that enables wireless data communication between digital devices. *Bluetooth* wireless technology operates within a range of about 10 meters (33 feet).

You do not need wires to get connected as you do with a USB connection, and you do not need to place the devices face to face as you do with wireless infrared technology. *Bluetooth* wireless technology is a global standard supported by thousands of companies. These companies produce products that meet the global standard.

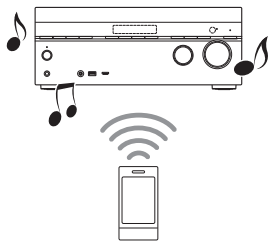

Check the websites for the latest information about compatible *Bluetooth* devices with URLs listed under “About support information” (page 127).

Supported *Bluetooth* version and profiles

Profile refers to a standard set of capabilities for various *Bluetooth* product capabilities. This receiver supports the following *Bluetooth* version and profiles.

Supported *Bluetooth* version:
Bluetooth Specification version 3.0

Supported *Bluetooth* profiles:
A2DP (Advanced Audio Distribution Profile): Receiving audio content of high-quality
AVRCP 1.3 (Audio Video Remote Control Profile): Controlling audio/video equipment; pausing, stopping, starting playback, volume control, etc.

Notes

- To be able to use the *Bluetooth* function, the *Bluetooth* device to be connected must support the same profile as this receiver. Even if the device supports the same profile, the functions may differ depending on the specifications of the *Bluetooth* device.
- The audio playback on this receiver may be delayed from that on the *Bluetooth* device because of the characteristics of the *Bluetooth* wireless technology.

Pairing the receiver with a *Bluetooth* device

Pairing is an operation where *Bluetooth* devices register with each other beforehand. Once a pairing operation is performed, it does not need to be performed again.

- 1 Place the *Bluetooth* device within 1 meter (3.3 feet) from this receiver.**
- 2 Press BLUETOOTH.**
You can also select “Bluetooth” from “Listen” in home menu.
- 3 Press OPTIONS.**
The options menu appears.
- 4 Select “Pairing”, then press \oplus .**

Note

Set the *Bluetooth* device in pairing mode. For details on setting the *Bluetooth* device in pairing mode, refer to the operating instructions supplied with the device.

5 Press \oplus to start the pairing.

“Pairing. Make the Bluetooth device ready to be detected by the receiver.” appears on the TV screen.

Note

If passkey is required on the *Bluetooth* device, enter “0000”.

6 Once pairing is completed, the device is automatically connected to the receiver.

Device name appears on the TV screen.

7 Start playback on the *Bluetooth* device.**8 Adjust the volume.**

Adjust the volume of the *Bluetooth* device first, if the volume level is still too low, adjust the volume level on the receiver.

To cancel pairing operation

Press RETURN .

Using the button on the receiver

1 Place the *Bluetooth* device within 1 meter (3.3 feet) from this receiver.

2 Press BLUETOOTH to select *Bluetooth* function.

3 Hold down BLUETOOTH for 2 seconds to activate the pairing mode of the receiver.

“PAIRING READY” appears and “BT” flashes quickly on the display panel. Perform step 4 within 5 minutes, otherwise pairing will be canceled. In this case, repeat this step.

4 Perform pairing on the *Bluetooth* device to detect this receiver.

For details, refer to the operating instructions of your *Bluetooth* device.

A list of detected devices may appear on the *Bluetooth* device display depending on the type of *Bluetooth* device. This receiver is displayed as “STR-DN1040”.

Note

When establishing a connection with this receiver, select the audio profile (A2DP, AVRCP) at the *Bluetooth* device. If the *Bluetooth* device does not support the AVRCP profile, you cannot perform playback or other operations with this receiver (page 78).

5 Select “STR-DN1040” on the *Bluetooth* device display.

If “STR-DN1040” is not displayed, repeat from step 1.

Note

If passkey is required on the display of the *Bluetooth* device, enter “0000”.

6 Once pairing is completed, the device is automatically connected to the receiver.

Device name appears and “BT” lights up on the display panel.

7 Start playback on the *Bluetooth* device.**8 Adjust the volume.**

Adjust the volume of the *Bluetooth* device first, if the volume level is still too low, adjust the volume level on the receiver.

To cancel pairing operation

Hold down BLUETOOTH after step 3.

“CANCEL” appears on the display panel.

Notes

- Passkey may be called “Passcode”, “PIN code”, “PIN number” or “Password”.
- You can pair up to 9 *Bluetooth* devices. If 10th *Bluetooth* device is paired, the least recently connected device will be replaced by the new one.
- Depending on the type of *Bluetooth* device, you can adjust the volume using the controls of the *Bluetooth* device.

Connecting to a Bluetooth device from this receiver

You can connect to a *Bluetooth* device from this receiver.

Check the following before playing music:

- The *Bluetooth* function of the *Bluetooth* device is turned on.
- The pairing has been completed (page 78).

1 Select “Connect/Disconnect” in step 4 in “Pairing the receiver with a Bluetooth device” (page 78).

The receiver automatically connects to the last connected *Bluetooth* device.

2 Press ► to start playback.

3 Adjust the volume.

Adjust the volume of the *Bluetooth* device first, if the volume level is still too low, adjust the volume level on the receiver.

To disconnect the Bluetooth device

Select “Connect/Disconnect” in step 4 in “Pairing the receiver with a *Bluetooth* device” (page 78).

To delete a paired Bluetooth device from the device list

Initialize the receiver (page 90).

Using the button on the receiver

1 Press BLUETOOTH to select *Bluetooth* function.

The receiver automatically connects to the last connected *Bluetooth* device.

If you cannot connect with a last connected *Bluetooth* device, press BLUETOOTH on the receiver.

Once the connection is established, proceed to step 3.

2 Establish a connection from the *Bluetooth* device.

For details, refer to the operating instructions of your *Bluetooth* device.

Note

Once the connection is established, the device name appears on the TV screen and “BT” lights up on the display panel.

3 Start playback from the *Bluetooth* device.

You can also press ► on the remote control.

4 Adjust the volume.

Adjust the volume of the *Bluetooth* device first, if the volume level is still too low, adjust the volume level on the receiver.

To disconnect the Bluetooth device

Press BLUETOOTH on the receiver. You can also disconnect from a *Bluetooth* device. For details, refer to the operating instructions of your *Bluetooth* device.

Notes

- Depending on the type of *Bluetooth* device, you can adjust the volume using the controls of the *Bluetooth* device.
- While connected to a *Bluetooth* device, this receiver cannot be detected and a connection cannot be established from another *Bluetooth* device.
- If you cannot connect with a paired *Bluetooth* device, perform the pairing operation between the receiver and the *Bluetooth* device again.
- If the input has been set to “BLUETOOTH” when you turn on the receiver, the receiver automatically connects to the last connected *Bluetooth* device.

To operate the *Bluetooth* device using the remote control

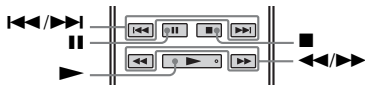

Press	Operation
▶*	Starts play.
	Pauses play.
■	Stops play.
◀◀/▶▶	Fast reverses or forwards.
◀◀/▶▶	Goes to the previous/next file.

* If no *Bluetooth* device is connected and you press ▶, the receiver automatically connects to the last connected *Bluetooth* device and play back the music.

Note

These operations may not be available for certain *Bluetooth* devices. In addition, the actual operations may differ depending on the connected *Bluetooth* device.

Setting the *Bluetooth* Standby mode

You can set the *Bluetooth* Standby mode so that the receiver can be controlled by the *Bluetooth* device even when the receiver is in standby mode.

1 Select “*Bluetooth* Standby” in step 4 in “Pairing the receiver with a *Bluetooth* device” (page 78).

2 Select “Yes”, then press (+).
The receiver turns on automatically when you establish the *Bluetooth* connection from the *Bluetooth* device.

To turn off this function

Select “No” in step 2.

Notes

- When the receiver is in standby mode, the I/O (on/standby) indicator on the front panel lights up in amber if “*Bluetooth* Standby” is set to “Yes”.
- You can only select this parameter when a *Bluetooth* device is paired.

Setting the *Bluetooth* audio codecs

You can enable and disable AAC (Advanced Audio Coding) audio.

1 Select “*Bluetooth* AAC” in step 4 in “Pairing the receiver with a *Bluetooth* device” (page 78).

2 Select “On” or “Off”, then press (+).
• **On:** AAC audio is available.
• **Off:** AAC audio is not available.

Notes

- You can enjoy high quality sound if the AAC is enabled.
- When you change the setting, the *Bluetooth* device is disconnected from the receiver automatically.

Checking the information of a connected *Bluetooth* device

You can check the *Bluetooth* device information by pressing DISPLAY repeatedly.
Each time you press DISPLAY, the display will change cyclically as follows:

Bluetooth device name → *Bluetooth* device address → Sound field currently applied → Volume level → Input you selected

“BRAVIA” Sync Features

What is “BRAVIA” Sync?

The “BRAVIA” Sync function allows communication between Sony products such as TV, Blu-ray Disc player, DVD player, AV amplifier, etc. that supports the Control for HDMI function.

By connecting Sony equipment that is compatible with the “BRAVIA” Sync with an HDMI cable (not supplied), operation is simplified as follows:

- One-Touch Play (page 83)
- System Audio Control (page 83)
- System Power-Off (page 83)
- Scene Select (page 84)
- Home Theatre Control (page 84)
- Remote Easy Control (page 84)

Control for HDMI is a mutual control function standard used by HDMI CEC (Consumer Electronics Control) for HDMI (High-Definition Multimedia Interface).

We recommend that you connect the receiver to products featuring “BRAVIA” Sync.

Notes

- You may use “One Touch Play”, “System Audio Control”, and “System Power-Off” function with non-Sony equipment. However, compatibility with all non-Sony equipment is not guaranteed.
- “Scene Select” and “Home Theatre Control” features are Sony proprietary functions. They cannot operate with non-Sony equipment.
- Equipment not compatible with “BRAVIA” Sync cannot activate these features.
- The Control for HDMI function does not work on an equipment connected to the HDMI OUT B jack of the receiver.
- Some of the operations may be supported when you connect a MHL device (page 85).

Preparing for the “BRAVIA” Sync

Set the Control for HDMI function of the receiver and the connected equipment to on individually.

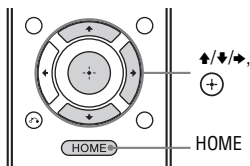

- 1 Select “Settings” from the home menu, then press (+).
The Settings menu list appears on the TV screen.
- 2 Select “HDMI”, then press (+).
- 3 Select “Control for HDMI”, then press (+).
- 4 Select “On”, then press (+).
The Control for HDMI function of the receiver is set to on.
- 5 Press HOME to exit the GUI menu.
- 6 Select the HDMI input of the receiver and TV to match the HDMI input of the connected equipment, so that the image from the connected equipment is displayed.
- 7 Set the Control for HDMI function of the connected equipment to on.
For details on setting the TV and connected equipment, refer to the operating instructions of the respective equipment.
- 8 Repeat steps 6 and 7 for other equipment that you want to use the Control for HDMI function.

Note

When you unplug the HDMI cable or change the connection, perform the steps above.

One-Touch Play

When you start playback the equipment connected to the receiver via an HDMI connection, the receiver and TV operation are simplified as follow:

Receiver and TV

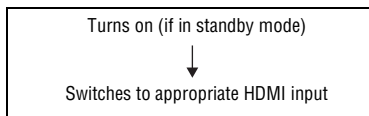

If you set “Pass Through” to “On” or “Auto” (page 99), then set the receiver to standby mode, sound and image can be output only from the TV.

Notes

- Be sure that the System Audio Control function is set to on using TV menu.
- When you play back from the connected equipment, the TV will momentarily lose the image and sound.
- Depending on the settings, the receiver may not turn on when “Pass Through” is set to “On” or “Auto”.

Tip

You can also select a connected equipment, such as Blu-ray Disc player, DVD player from the TV menu. The receiver and TV will automatically switch to the appropriate HDMI input.

System Audio Control

You can enjoy the TV sound from the speakers connected to the receiver by a simple operation.

You can operate System Audio Control function using the TV menu. For details, refer to the operating instructions of the TV.

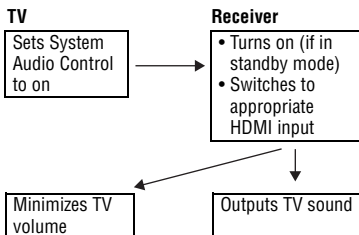

You can also use the System Audio Control function as follows.

- If you turn on the receiver while the TV is turned on, the System Audio Control function will automatically activate to output TV sound through the speakers connected to the receiver. However, if you turn off the receiver, the sound will output from the TV speakers.
- When you enjoy the TV sound from the speakers connected to the receiver, you can adjust the volume or turn off the sound temporarily by using the TV’s remote control.

Notes

- If System Audio Control does not function according to your TV setting, refer to the operating instructions of the TV.
- When “Control for HDMI” is set to “On”, the “Audio Out” settings in the HDMI Settings menu will set automatically based on the System Audio Control settings (page 99).
- If the TV is turned on before turning on the receiver, the TV will momentarily lose the sound output.

System Power-Off

When you turn the TV off, using the power button on the TV’s remote control, the receiver and the connected equipment turn off automatically.

You can also use the receiver's remote control to turn off the TV.

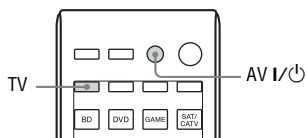

Press TV, then press AV I/⏻.

The TV, receiver and the connected equipment are turned off.

Notes

- Set the TV power supply interlock function to on before using the System Power-Off function. For details, refer to the operating instructions of the TV.
- Depending on the condition of the connected equipment, it may not be turned off. For details, refer to the operating instructions of the connected equipment.
- If you use the System Power-Off function with a non-Sony TV, program the remote control according to the maker of the TV.

Scene Select

The optimum picture quality and sound field are selected automatically according to the scene selected on your TV. For details on the operation, refer to the operating instructions of the TV.

Note

The sound field may not switch depending on the TV.

Correspondence table

Scene setting on the TV	Sound field
Cinema	HD-D.C.S.
Sports	Sports
Music	Live Concert
Animation	A.F.D. Auto

Scene setting on the TV	Sound field
Photo	A.F.D. Auto
Game	A.F.D. Auto
Graphics	A.F.D. Auto

Home Theatre Control

If a "Home Theatre Control"-compatible TV is connected to the receiver, an icon for Internet based applications appears on the connected TV.

You can switch an input of the receiver or switch sound fields by using your TV's remote control. You can also adjust the level of the center speaker or the subwoofer, or adjust the settings of "Sound Optimizer" (page 59), "Dual Mono" (page 98), or "A/V Sync" (page 98).

Note

To use the Home Theatre Control function, your TV must be able to access a broadband service. For details, refer to the operating instructions of your TV.

Remote Easy Control

You can use the TV remote control to operate the menu of the receiver. For details, refer to the operating instructions of the TV.

Select the receiver (AV AMP) recognized by the TV.

Notes

- The receiver is recognized as "Tuner (AV AMP)" by the TV.
- Your TV must be compatible with the link menu.
- Depending on the type of TV, some of the operations may not be available.

Controlling the MHL device

By connecting MHL device with a MHL cable (not supplied), operation is simplified as follows:

- One-Touch Play (page 85)
- Remote Easy Control (page 85)

Notes

- This function allows communication with Sony "BRAVIA" Sync-compatible TV using an HDMI cable (not supplied).
- This function may not work depending on the connected MHL device.
- This function can only work when
 - The receiver is turned on.
 - The "Control for HDMI" is set to "On".
 - The MHL device is connected via a MHL cable (not supplied) to the HDMI/MHL (VIDEO 2 IN) jack (page 32).

One-Touch Play

The receiver switches to the appropriate input when you connect, playback, etc. from your MHL device.

Remote Easy Control

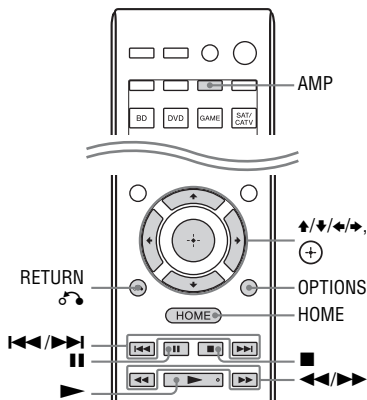

You can use $\uparrow/\downarrow/\leftarrow/\rightarrow$, \oplus , RETURN \hookrightarrow , OPTIONS, HOME*, \blacktriangleright , \parallel , \blacksquare , $\blacktriangleleft/\blacktriangleright$, $\blacktriangleleft/\blacktriangleright$ buttons on the remote control to control your MHL device.

* Hold down HOME to display the home menu of the MHL device.

Note

Be sure to press AMP before you use the buttons to control your MHL device.

Switching the monitors that output the HDMI video signals

When you have two monitors connected to the HDMI OUT A and HDMI OUT B jacks, you can switch the output for these two monitors using the HDMI OUTPUT button on the remote control.

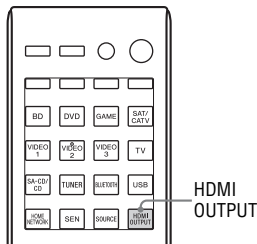

1 Turn on the receiver and the two monitors.

2 Press HDMI OUTPUT.

Each time you press the button, the output will be switched as follows:
HDMI A \rightarrow HDMI B \rightarrow HDMI A + B \rightarrow HDMI OFF \rightarrow HDMI A...

Notes

- If the compatible video format differs between the monitors connected to the HDMI OUT A jack and the HDMI OUT B jack of the receiver, "HDMI A + B" may not work.
- Depending on the playback equipment you connect, "HDMI A + B" may not work.

Other Operations

Switching between digital and analog audio (INPUT MODE)

When you connect equipment to both digital and analog audio input jacks on the receiver, you can fix the audio input mode to either of them, or switch from one to the other, depending on the type of material you intend to watch.

1 Press the input buttons to select the input.

You can also turn INPUT SELECTOR on the receiver.

2 Press INPUT MODE.

The selected audio input mode appears on the display panel.

- **AUTO:** Gives priority to digital audio signals. If there are more than one digital connection, HDMI audio signals have priority.

If there are no digital audio signals, analog audio signals are selected.

When TV input is selected, priority is given to the Audio Return Channel (ARC) signals. If your TV is not compatible with the ARC function, the digital optical audio signals are selected.

If the Control for HDMI functions of both the receiver and the TV are not activated, the ARC does not work.

- **COAX:** Specifies the digital audio signals input to the COAXIAL jack.
- **OPT:** Specifies the digital audio signals input to the OPTICAL jack.
- **ANALOG:** Specifies the analog audio signals input to the AUDIO IN (L/R) jacks.

Notes

- Based on the input, “-----” appears on the display panel, and other modes cannot be selected.
- When “2ch Analog Direct” is being used, audio input is set to “ANALOG”. You cannot select other modes.

Using other video/audio input jacks (Input Assign)

You can reassign video and/or audio signals to another input jacks.

After you have reassigned the input jacks, you can use the input button (or INPUT SELECTOR on the receiver) to select the equipment you connected.

Component video and digital audio input assign

You can reassign the COMPONENT VIDEO and DIGITAL input jacks to other input if the default settings of the jacks do not correspond to your connected equipment.

Example:

When you connect the DVD player to the OPTICAL IN 1 (SAT/CATV) and COMPONENT VIDEO IN 1 (SAT/CATV) jacks.

- Assign the OPTICAL IN 1 (SAT/CATV) jack to “DVD”.
- Assign the COMPONENT VIDEO IN 1 (SAT/CATV) jacks to “DVD”.

1 Select “Settings” from the home menu, then press \oplus .

The Settings menu list appears on the TV screen.

2 Select “Input”, then press \oplus .

- 3** Select the input name you want to assign, then press **(+)**.
- 4** Press **←/→** repeatedly to select “COMPONENT” or “OPT/COAX”.
- 5** Press **↑/↓** repeatedly to select the jack you want to assign, then press **(+)**.

Input name		BD	DVD	GAME	SAT/ CATV	VIDEO 1	VIDEO 2	VIDEO 3	SA-CD/ CD
Assignable video input jacks	IN2	○	○*	○	○	○	○	○	○
	IN1	○	○	○	○*	○	○	○	○
	None	○*	○	○*	○	○*	○*	○*	○*
Assignable audio input jacks	OPT 2	○	○	○	○	○	○	○	○
	OPT 1	○	○	○	○*	○	○	○	○
	COAX	○	○*	○	○	○	○	○	○
	None	○*	○	○*	○	○*	○*	○*	○*

* Default setting

Notes

- When you assign the digital audio input, the INPUT MODE setting may change automatically.
- One reassignment is allowed for each input.

Using a bi-amplifier connection

- 1** Select “Settings” from the home menu, then press **(+)**.
The Settings menu list appears on the TV screen.
- 2** Select “Speaker”, then press **(+)**.
- 3** Select “Speaker Connection”, then press **(+)**.
- 4** Select the appropriate speaker pattern so that there are no surround back speakers and front high speakers, then press **(+)**.

- 5** Select “Bi-Amplifier Connection”, then press **(+)**.

The same signals output from the SPEAKERS FRONT A terminals can be output from the SPEAKERS SURROUND BACK/BI-AMP/FRONT HIGH/FRONT B terminals.

- 6** Press **(+)** to save the selection.

To exit the menu

Press HOME.

Notes

- Select “Bi-Amplifier Connection” before you perform Auto Calibration.
- When you select “Bi-Amplifier Connection”, the speaker level and distance settings of the surround back speakers and front high speakers become invalid, and those of the front speakers are used.

Using multi-zone features

You can enjoy sounds from the equipment connected to the receiver in a zone other than the main zone. For example, you can watch the DVD in the main zone and listen to the CD in zone 2.

When using an IR repeater (not supplied), you can operate both equipment in the main zone and Sony receiver in zone 2 from zone 2.

To operate the receiver from zone 2

You can operate the receiver without pointing the remote control towards the receiver if you connect an IR repeater (not supplied) to the IR REMOTE jack.

Use an IR repeater when you install the receiver in a place where signals from the remote control cannot reach.

Making a zone 2 connection

Outputs sound from speakers in zone 2 using the receiver and another amplifier.

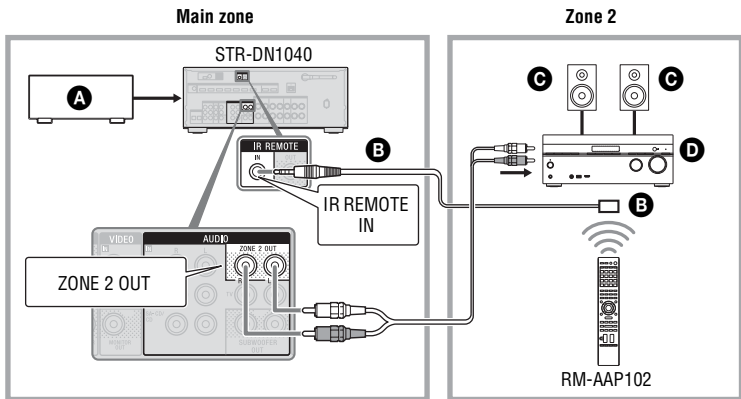

- A** Audio equipment
- B** IR repeater (not supplied)
- C** Speakers
- D** Sony Amplifier/Receiver

Operating the receiver from zone 2

The following operations are described for connecting an IR repeater and operating the receiver in zone 2. When an IR repeater is not connected, use this receiver in the main zone.

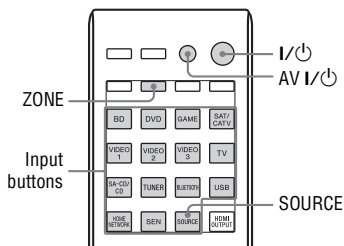

- 1 Turn on the main receiver (this receiver).**
- 2 Turn on the receiver in zone 2.**
- 3 Press ZONE.**
The remote control switches to zone 2.
- 4 Press I/⏻.**
The zone function is activated.
- 5 Press the input buttons to select the source you want.**
- 6 Adjust to a suitable volume using the receiver in zone 2.**

Available zone 2 operations

INPUT	ZONE 2 ¹⁾
BD	–
DVD	–
GAME	–
SAT/CATV ²⁾	○
VIDEO 1 ²⁾	○
VIDEO 2	–

INPUT	ZONE 2 ¹⁾
VIDEO 3	–
TV	–
SA-CD/CD	○
TUNER ³⁾	○
BLUETOOTH	–
USB	–
HOME NETWORK	–
SEN	–
SOURCE	○

- ¹⁾ For zone 2, only analog audio signals are output.
- ²⁾ Only when SOURCE is selected, the signals of the current input in main zone are output.
- ³⁾ You can select either “FM” or “AM” from the main zone and zone 2. Priority is given to the choice which has most recently been selected, even if a different choice has already been selected in one of the zones.

To exit the zone 2 operation

Press ZONE, then press I/⏻.

Tips

- Even when this receiver is in standby mode (press I/⏻ on the remote control to turned off this receiver), the receiver in zone 2 remains turned on.
- When the receiver is in standby mode, the I/⏻ (on/standby) indicator on the front panel lights up in amber if the receiver in zone 2 is turned on.
- AirPlay function is available in main zone only.

Reverting back to the factory default settings

You can clear all memorized settings and revert the receiver back to the factory default settings by performing the following procedure. This procedure can also be used to initialize the receiver before you use it for the first time. Be sure to use the buttons on the receiver to perform this operation.

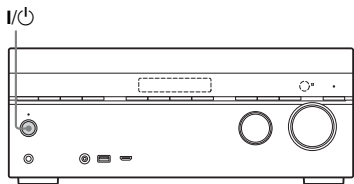

- 1 Press I/⏻ to turn off the receiver.**
- 2 Hold down I/⏻ for 5 seconds.**
The “CLEARING” appears on the display panel for a while, then changes to “CLEARED!”. Changes or adjustments made to the settings are now reset to the defaults.

Note

It takes about a few minutes for the memory to be cleared completely. Do not turn the receiver off until “CLEARED!” appears on the display.

Adjusting Settings

Using the Settings menu

You can adjust various settings for speakers, surround effects, etc. using the Settings menu.

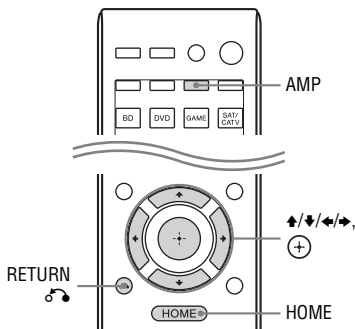

- 1 Press AMP, then press HOME.**
The home menu is displayed on the TV screen.

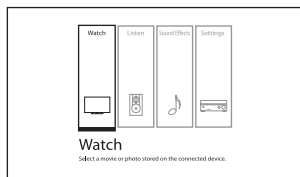

- 2** Select “Settings”, then press **+** to enter the menu mode.

The Settings menu list appears on the TV screen.

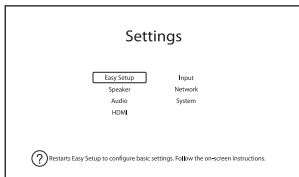

- 3** Select the menu item you want, then press **+**.
Example: When you select “Speaker”.

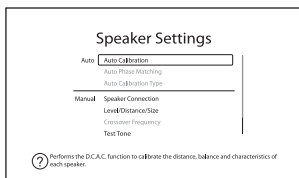

- 4** Select the parameter you want, then press **+**.

To return to the previous screen

Press RETURN .

To exit the menu

Press HOME to display the home menu, then press HOME again.

Settings menu list

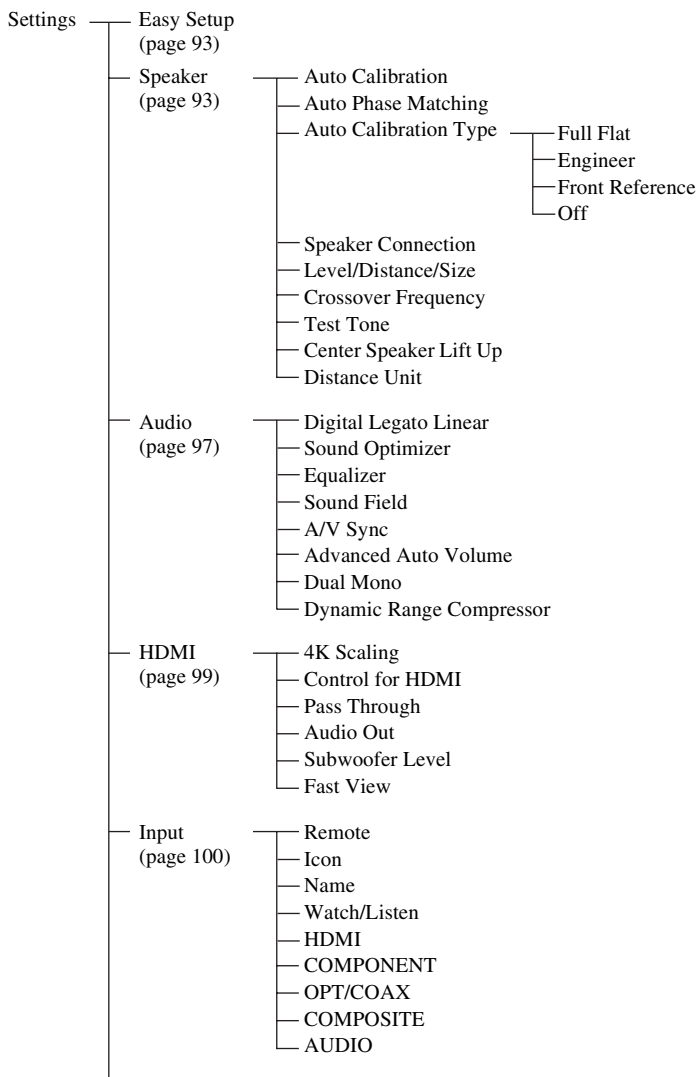

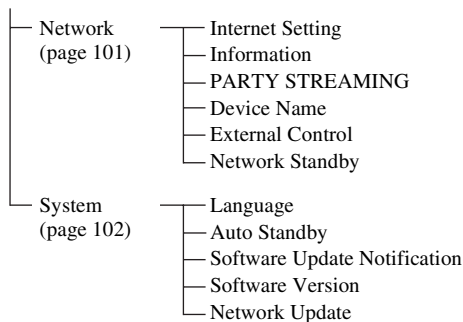
**Note**

Menu parameters displayed on the TV screen vary, depending on the current settings or the status of the selected icon.

Easy Setup

Re-runs the Easy Setup to make the basic settings. Follow the on-screen instructions (page 43).

Speaker Settings menu

You can adjust each speaker manually. You can also adjust the speaker levels after the Auto Calibration is completed.

Note

The speaker settings are only for the current seating position.

■ Auto Calibration

Lets you perform the automatic calibration from your seating position automatically.

- 1 Follow the instructions on the TV screen, then press **+** to select "Start".

The measurement starts in five seconds.

The measurement process will take approximately 30 seconds with a test tone.

When the measurement ends, a beep sounds and the screen switches.

Note

If an error code or warning message appears on the screen, see "Message list after Auto Calibration measurement" (page 94).

- 2 Select the item you want, then press **+**.

- **Save:** Save the measurement results and exits the setting process.
- **Retry:** Performs the Auto Calibration again.
- **Discard:** Exits the setting process without saving the measurement results.

- 3 Save the measurement result. Select "Save" in step 2.

Note

If you reposition your speaker, we recommend that you perform Auto Calibration again to enjoy the surround sound.

Tips

- You can change the unit of distance in “Distance Unit” in the Speaker Settings menu (page 97).
- The size of a speaker (“Large”/“Small”) is determined by the low frequency characteristics. The measurement results may vary, depending on the position of the optimizer microphone and speakers, and the shape of the room. It is recommended that you apply the measurement results. However, you can change those settings in the Speaker Settings menu. Save the measurement results first, then try to change the settings.

To check the Auto Calibration results

To check error code or warning message obtained in “Auto Calibration” (page 94), proceed with the following steps.

When error code appears

Check the error and perform Auto Calibration again.

- 1 Select “Retry”, then press ⊕.
- 2 Repeat steps 1 to 3 in “Auto Calibration” (page 93).

When warning message appears

Check the warning message and select “Ok”.

Message list after Auto Calibration measurement

Display and explanation

Code 30

Headphones are connected to the PHONES jack on the receiver. Remove the headphones and perform the Auto Calibration again.

Code 31

The SPEAKERS is set to off. Set to other speaker settings and perform the Auto Calibration again.

Display and explanation

Code 32**Code 33**

Speakers were not detected or not connected properly.

- None of the front speakers are connected or only one front speaker is connected.
- Either the surround left or surround right speaker is not connected.
- Surround back speakers or front high speakers are connected even though surround speakers are not connected. Connect the surround speaker(s) to the SPEAKERS SURROUND terminals.
- The surround back speaker is connected only to the SPEAKERS SURROUND BACK/BI-AMP/FRONT HIGH/FRONT B R terminals. When you connect only one surround back speaker, connect it to the SPEAKERS SURROUND BACK/BI-AMP/FRONT HIGH/FRONT B L terminals.
- Either the front high left or front high right speaker is not connected.

The optimizer microphone is not connected. Make sure that the optimizer microphone is connected properly and perform the Auto Calibration again.

If the optimizer microphone is connected properly but the error code still appears, the optimizer microphone cable may be damaged.

Warning 40

The measurement process has completed with high noise level detection. You may be able to achieve better results if you try in a quiet environment again.

Warning 41**Warning 42**

The input from the microphone is too big.

- The distance between the speaker and the microphone may be too close. Set them apart and perform the measurement again.

Warning 43

The distance and position of a subwoofer cannot be detected. This may be caused by noise. Try to perform the measurement in a quiet environment.

Tip

Depending on the position of the subwoofer, the measurement results may vary. However, there will be no problems even if you continue to use the receiver with that value.

■ Auto Phase Matching (A.P.M.)

Lets you set the A.P.M. function in the DCAC function (page 38).

It calibrates the phase characteristics of the speakers and ensures a well-coordinated surround space.

- **Auto:** Switches the A.P.M. function on or off automatically.
- **Off:** Does not activate the A.P.M. function.

Notes

- This function does not work in the following cases.
 - “2ch Analog Direct” is being used.
 - Headphones are connected.
 - “Auto Calibration” has not been performed.
- The receiver may play back signals at a lower sampling frequency than the actual sampling frequency of the input signals, depending on the audio format.

■ Auto Calibration Type

Lets you select the calibration type after you have performed the Auto Calibration and saved the settings.

- **Full Flat:** Makes the measurement of frequency from each speaker flat.
- **Engineer:** Sets to “the Sony listening room standard” frequency characteristics.
- **Front Reference:** Adjusts the characteristics of all the speakers to match the characteristics of the front speaker.
- **Off:** Sets the Auto Calibration equalizer level to off.

■ Speaker Connection

Lets you select the speaker pattern and set the assignment for the SPEAKERS SURROUND BACK/BI-AMP/FRONT HIGH/FRONT B terminals.

- 1 Select the speaker pattern you want, then press \oplus .

- 2 Set the assignment for the SPEAKERS SURROUND BACK/BI-AMP/FRONT HIGH/FRONT B terminals.

- **Bi-Amplifier Connection**
- **Front B Speakers**
- **Not Assigned**

Note

You can only set the assignment for the SPEAKERS SURROUND BACK/BI-AMP/FRONT HIGH/FRONT B terminals if the speaker pattern is set to a setting without surround back and front high speakers.

■ Level/Distance/Size

You can adjust the level, distance, and size of the selected speaker.

To adjust the speaker level

You can adjust each speaker’s level (front left/right, front high left/right, center, surround left/right, surround back left/right, subwoofer).

- 1 Select the speaker on the screen for which you want to adjust the level, then press \oplus .
- 2 Select “Level”, then press \uparrow/\downarrow to adjust the level.

You can adjust the level from -10.0 dB to $+10.0$ dB in 0.5 dB intervals.

Note

When one of the sound fields for music is selected, no sound is output from the subwoofer if all the speakers are set to “Large” in the Speaker Settings menu. However, the sound will be output from the subwoofer if

- the digital input signal contains LFE signals.
- the front or surround speakers are set to “Small”.
- “Multi Stereo”, “PLII Movie”, “PLII Music”, “PLIIX Movie”, “PLIIX Music”, “PLIIZ Movie”, “PLIIZ Music”, “HD-D.C.S.” or “Portable Audio” is selected.

To adjust the distance from the seating position to each speaker

You can adjust the distance from the seating position to each speaker (front left/right, front high left/right, center, surround left/right, surround back left/right, subwoofer).

1 Select the speaker on the screen for which you want to adjust the distance from the seating position, then press **+**.

2 Select "Distance", then press **▲/▼** to adjust the distance.

You can adjust the distance from 1 m 0 cm to 10 m 0 cm (3 feet 3 inches to 32 feet 9 inches) in 1 cm (1 inch) intervals.

Notes

- Depending on the speaker pattern setting, some parameters may not be available.
- This function does not work when "2ch Analog Direct" is being used.

To adjust the size of each speaker

You can adjust each speaker's (front left/right, front high left/right, center, surround left/right, surround back left/right) size.

1 Select the speaker on the screen for which you want to adjust the size, then press **+**.

2 Select "Size", then press **▲/▼** to adjust the size.

- **Large:** If you connect large speakers that will effectively reproduce bass frequencies, select "Large". Normally, select "Large".
- **Small:** If the sound is distorted, or you feel a lack of surround effects when using multi channel surround sound, select "Small" to activate the bass redirection circuitry and output the bass frequencies of each channel from the subwoofer or other "Large" speakers.

Note

This function does not work when "2ch Analog Direct" is being used.

Tips

- The "Large" and "Small" settings for each speaker determine whether the internal sound processor will cut the bass signal from that channel.

When the bass is cut from a channel, the bass redirection circuitry sends the corresponding bass frequencies to the subwoofer or other "Large" speakers.

However, since bass sound has a certain amount of directionality, it is best not to cut it, if possible. Therefore, even when using small speakers, you can set them to "Large" if you want to output the bass frequencies from that speaker. On the other hand, if you are using a large speaker, but prefer not to have bass frequencies output from that speaker, set it to "Small".

If the overall sound level is lower than you prefer, set all speakers to "Large". If there is not enough bass, you can use the equalizer to boost the bass levels.

- The surround back speakers will be set to the same setting as that of the surround speakers.
- When the front speakers are set to "Small", the center, surround, and surround back/front high speakers are also automatically set to "Small".
- If you do not use the subwoofer, the front speakers are automatically set to "Large".
- When headphones are connected, Size and Distance cannot be set.

■ Crossover Frequency

Lets you set the bass crossover frequency of speakers that the speaker size has been set to "Small" in the Speaker Settings menu. Measured speaker crossover frequency is set for each speaker after the Auto Calibration.

1 Select the speaker on the screen for which you want to adjust the crossover frequency.

2 Press **▲/▼** to set the crossover frequency.

Notes

- When headphones are connected, this function does not work.

- The surround back speakers will be set to the same setting as that of the surround speakers.

■ Test Tone

Lets you select the test tone type on the “Test Tone” screen.

Tips

- To adjust the level of all speakers at the same time, press \triangle +/- . You can also use MASTER VOLUME on the receiver.
- The adjusted value is shown on the TV screen during adjustment.

To output test tone from each speaker

You can output test tone from the speakers in sequence.

- 1 Select “Test Tone”, then press \oplus .
- 2 Adjust the parameter, then press \oplus .
 - **Off**
 - **Auto:** The test tone is output from each speaker in sequence.
 - **L, C, R, SR, SL, SB*, SBL, SBR, FHL, FHR, SW:** You can select which speakers will output the test tone.
 - * “SB” appears when only one surround back speaker is connected.
- 3 Adjust the speaker level, then press \oplus .

■ Center Speaker Lift Up

By using the front high speakers, you can lift up the sounds of the center speaker to an appropriate height on the screen, allowing you to enjoy natural representation without discomfort.

- **1 – 10**
- **Off**

Note

This function does not work in the following cases.

- Headphones are connected.
- There is no center speaker.
- There are no front high speakers.
- The “2ch Stereo”, “2ch Analog Direct”, and “Multi Stereo” sound field are being used.
- The sound field for music is being used.

■ Distance Unit

Lets you select the unit of measurement for setting distances.

- **feet:** The distance is displayed in feet.
- **meter:** The distance is displayed in meters.

Audio Settings menu

You can adjust settings for the audio to suit your preference.

■ Digital Legato Linear (D.L.L.)

The D.L.L. function is Sony proprietary technology that allows low quality digital audio signals and analog audio signals to be played back with high quality sound.

- **Auto 1:** This function is available for lossy compression audio formats and analog audio signals.
- **Auto 2:** This function is available for Linear PCM signals, as well as lossy compression audio formats and analog audio signals.
- **Off**

Notes

- This function may not work, depending on the content via a USB device, or a home network.
- This function works when “2ch Stereo”, “A.F.D. Auto”, “Multi Stereo” or “Headphone (2ch)” is selected. However, this function does not work in the following cases.
 - “FM TUNER” or “AM TUNER” input is selected.
 - Linear PCM signals with a sampling frequency of other than 44.1 kHz are being received.
 - Dolby Digital Plus, Dolby Digital EX, Dolby TrueHD, DTS 96/24, DTS-HD Master Audio, or DTS-HD High Resolution Audio signals are being received.
 - During network function, signals with a sampling frequency of other than 44.1 kHz is being received.

■ Sound Optimizer

Lets you set the sound optimizer function. For details, see “Using the Sound Optimizer function” (page 59).

- **Normal**
- **Low**
- **Off**

■ Equalizer

Lets you adjust the bass and treble level for each speaker. For details, see “Adjusting the equalizer” (page 58).

■ Sound Field

Lets you select a sound effect applied to input signals. For details, see “Enjoying Sound Effects” (page 55).

■ A/V Sync (Synchronizes audio with video output)

Lets you delay the output of audio to minimize the time gap between audio output and visual display. This function is useful when you use a large LCD or plasma monitor or a projector.

- **HDMI Auto:** The time gap between audio output and visual display for the monitor connected via an HDMI connection will be adjusted automatically based on the information for the TV. This feature is available only when the monitor supports the A/V Sync function.
- **0 ms – 300 ms:** You can adjust the delay from 0 ms to 300 ms in 10 ms intervals.

Notes

- This function does not work when “2ch Analog Direct” is being used.
- The delay time may vary depending on audio format, sound field, speaker pattern and speaker distance settings.

■ Advanced Auto Volume

This receiver can adjust the volume automatically depending on the input signal or content from the connected equipment.

This function is useful, for example, when the sound of a commercial is louder than the TV programs.

- **On**
- **Off**

Notes

- Be sure to reduce the volume level before you turn on/off this function.
- As this function is available only when Dolby Digital, DTS or Linear PCM signals are input, the sound may suddenly increase when you switch to other formats.
- This function does not work in the following cases.
 - Linear PCM signals with a sampling frequency of more than 48 kHz are being received.
 - Dolby Digital Plus, Dolby TrueHD, DTS 96/24, DTS-HD Master Audio, or DTS-HD High Resolution Audio signals are being received.
 - “2ch Analog Direct” is being used.

■ Dual Mono (Digital broadcast language selection)

Lets you select the language you want when you listen to the dual audio of a digital broadcast when available. This feature only functions for Dolby Digital sources.

- **Main:** Sound of the main language will be output.
- **Sub:** Sound of the sub language will be output.
- **Main/Sub:** Sound of the main language will be output through the front left speaker and sound of the sub language will be output through the front right speaker simultaneously.

■ Dynamic Range Compressor

Lets you compress the dynamic range of the soundtrack. This may be useful when you want to watch movies at low volumes late at night. Dynamic range compression is possible with Dolby Digital sources only.

- **Auto:** The dynamic range is compressed automatically.
- **On:** The dynamic range is compressed as intended by the recording engineer.
- **Off:** The dynamic range is not compressed.

HDMI Settings menu

You can adjust the required settings for equipment connected to the HDMI jacks.

■ 4K Scaling

Lets you up-convert the video signals to 4K and output through the HDMI OUT jacks of the receiver.

- **Auto:** Enable video scaling control to 4K HDMI output automatically if you connect a 4K-compatible TV.
- **Off:** Does not activate this function.

Note

This function works only when video signals from VIDEO IN, COMPONENT VIDEO IN, and HDMI IN jacks are being received. The HDMI video input signals must be 1080p/24 kHz.

■ Control for HDMI

Lets you turn the Control for HDMI function on or off. For details, see “Preparing for the “BRAVIA” Sync” (page 82).

- **On**
- **Off**

Notes

- When you set “Control for HDMI” to “On”, “Audio Out” may be changed automatically.
- When the receiver is in standby mode, the I/⏻ (on/standby) indicator on the front panel lights up in amber if “Control for HDMI” is set to “On”.

■ Pass Through

Lets you output the HDMI signals to the TV even when the receiver is in standby mode.

- **Auto:** When the TV is turned on while the receiver is in the standby mode, the receiver outputs HDMI signals from the receiver’s HDMI OUT jack. Sony recommends this setting if you use a “BRAVIA” Sync-compatible Sony TV. This setting saves power in the standby mode when compared with the “On” setting.
- **On:** When the receiver is in the standby mode, the receiver continuously outputs HDMI signals from the receiver’s HDMI OUT jack.
- **Off:** The receiver does not output HDMI signals when in standby mode. Turn on the receiver to enjoy the connected equipment’s source on the TV. This setting saves power in the standby mode when compared with the “On” setting.

Notes

- When the receiver is in standby mode, the I/⏻ (on/standby) indicator on the front panel lights up in amber if “Pass Through” is set to “On” or “Auto”.
- When “Auto” is selected, it may take a little more time for the image and sound to be output to the TV than when “On” is selected.

■ Audio Out

Lets you set the HDMI audio signals output from the playback equipment connected to the receiver via an HDMI connection.

- **AMP:** The HDMI audio signals from the playback equipment are only output to the speakers connected to the receiver. Multi channel sound can be played back as it is.

Note

- Audio signals are not output from the TV’s speaker when “Audio Out” is set to “AMP”.
- **TV + AMP:** The sound is output from TV’s speaker and the speakers connected to the receiver.

Notes

- The sound quality of the playback equipment depends on the TV's sound quality, such as the number of channels, and the sampling frequency, etc. If the TV has stereo speakers, the sound output from the receiver is also in stereo as that of the TV, even if you play back multi channel source.
- When you connect the receiver to a video equipment (projector, etc.), sound may not be output from the receiver. In this case, select "AMP".

Subwoofer Level

Lets you set the level of the subwoofer to 0 dB or +10 dB when PCM signals are input via an HDMI connection. You can set the level for each input to which an HDMI input jack is assigned independently.

- **Auto:** Automatically sets the level to 0 dB or +10 dB, depending on the audio stream.
- **+10 dB**
- **0 dB**

Fast View

Lets you set the operation of Fast View. HDMI BD, DVD, GAME, VIDEO 1, and VIDEO 2 input support the Fast View function.

- **Auto:** You can select HDMI input faster than the normal selection.
- **Off:** Fast View and Preview for HDMI functions are not available.

Input Settings menu

You can adjust the settings for the connections of the receiver and other equipment.

Remote

Lets you select the input.

- **BD, DVD, GAME, SAT/CATV, VIDEO 1, VIDEO 2, VIDEO 3, TV, SA-CD/CD**

Icon

Lets you set the icon displayed on the Watch/Listen menu.

Name

Lets you set the name displayed on the Watch/Listen menu.

You can enter a name of up to 8 characters for inputs and display it.

It is more recognizable having the equipment named on the display than the jacks.

- 1 Select "Input" from the Settings menu, then press (+).
- 2 Select the input you want to name, then press (+).
- 3 Select "Name", then press (+).
The on-screen keyboard appears on the TV screen.
- 4 Press $\blacktriangleleft/\blacktriangleright/\blacktriangleleft/\blacktriangleright$ and (+) to select a character one by one to enter the name.
- 5 Select "Enter", then press (+).
The name you entered is registered.

Note

Some letters that can be displayed on the TV screen cannot be displayed on the display panel.

Watch/Listen

Lets you set whether an input is displayed on the Watch menu or the Listen menu.

- **W:** Displays an input to the Watch menu.
- **L:** Displays an input to the Listen menu.
- **W/L:** Displays an input to both the Watch and Listen menus.

HDMI

COMPONENT

Lets you set the video input jack(s) assigned to each input. For details, see "Using other video/audio input jacks (Input Assign)" (page 86).

- **IN2**
- **IN1**
- **None**

■ OPT/COAX

Lets you set the audio input jack(s) assigned to each input. For details, see “Using other video/audio input jacks (Input Assign)” (page 86).

- OPT 2
- OPT 1
- COAX
- None

■ COMPOSITE

■ AUDIO

Network Settings menu

You can adjust the settings for the network. The Network Settings menu is available only when the Home Network or SEN function is selected.

■ Internet Setting

Lets you make the network settings. For details, see “Configuring the network settings of the receiver” (page 39).

- Wired
- Wireless

■ Information

Lets you check the network information. You can check the settings* for “Connection Type”, “Connection Status”, “IP Address Setting”, “IP Address”, “Subnet Mask”, “Default Gateway”, “DNS Settings”, “Primary DNS”, “Secondary DNS”, and “MAC Address”.

* The setting items during setup differ depending on the network environment and connection type.

■ PARTY STREAMING

Lets you set the receiver to use the PARTY STREAMING function.

- **On:** The receiver can be detected by other devices on the home network. The receiver can start or close a PARTY, and can join or leave a PARTY.



- **Off:** The receiver can be detected by other devices on the home network. However, the receiver cannot start or close a PARTY, and cannot join or leave a PARTY.

■ Device Name

Lets you assign a device name to the receiver up to 30 characters to be easily recognizable by other devices on the home network.

- 1 Select “Device Name”, then press .

The on-screen keyboard appears on the TV screen.

- 2 Press  and  to select a character one by one to enter the name.

- 3 Select “Enter”, then press .

The name you entered is registered.

Tip

The default device name is “STR-DN1040 *****”.

“*****” is the last 6 digits of MAC Address of the receiver.

■ External Control

Lets you turn the control mode for maintenance and service on or off.

- On
- Off

■ Network Standby

While the “Network Standby” mode is set to “On”, the receiver can always be connected and controlled over the network.

- **On:** The network function works even when the receiver is in standby mode, and resume operations when controlled over the network.
- **Off:** The network function turns off when the receiver is in standby mode. The receiver takes more time to resumes operation when powered on again.

Note

When the receiver is in standby mode, the  (on/standby) indicator on the front panel lights up in amber if “Network Standby” is set to “On”.

System Settings menu

You can adjust the settings of the receiver.

■ Language

Lets you select the language for the messages on the screen.

- English
- Español
- Français
- Deutsch

■ Auto Standby

Lets you set the receiver switch to standby mode automatically when you do not operate the receiver or when there is no signals input to the receiver.

- **On:** Switches to standby mode after approximately 20 minutes.
- **Off:** Does not switch to standby mode.

Notes

- This function does not work in the following cases.
 - “FM TUNER”, “AM TUNER”, “HOME NETWORK” or “SEN” input is selected.
 - AirPlay or PARTY STREAMING function is being used.
 - The software of the receiver is being updated.
- If you use the Auto standby mode and the Sleep Timer at the same time, the Sleep Timer has priority.

■ Software Update Notification

Lets you set whether or not to inform you of newer software version information on the TV screen.

- On
- Off

Note

- New software version information does not appear in the following cases.
- The latest version is already being used.
 - The receiver cannot obtain data via a network.

■ Software Version

Lets you check the software version of the receiver.

■ Network Update

Lets you update the software of the receiver to the latest version. For details, see “Updating the software” (page 75).

Operating without using the GUI

You can operate this receiver using the display panel even if the TV is not connected to the receiver.

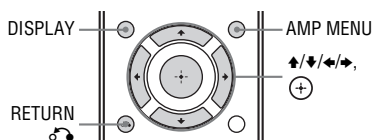

Using the menu on the display panel

- 1 Press AMP MENU.**
The menu is displayed on the display panel of the receiver.
- 2 Press \uparrow/\downarrow repeatedly to select the menu you want, then press \oplus .**
- 3 Press \uparrow/\downarrow repeatedly to select the parameter you want to adjust, then press \oplus .**
- 4 Press \uparrow/\downarrow repeatedly to select the setting you want, then press \oplus .**

To return to the previous display

Press \leftarrow or RETURN \curvearrowright .

To exit the menu

Press AMP MENU.

Note

Some parameters and settings may appear dimmed on the display panel. This means that they are either unavailable or fixed and unchangeable.

Overview of the menus

The following options are available in each menu. For details on navigating through menus, see page 102.

Menu [Display]	Parameters [Display]	Settings
Auto Calibration settings [<AUTO CAL>]	Auto Calibration start [A.CAL START]	
	Auto Calibration type ^{a)} [CAL TYPE]	FULL FLAT, ENGINEER, FRONT REF, OFF
	Auto Phase Matching ^{a)} [A.P.M.]	A.P.M. AUTO, A.P.M. OFF
Level settings [<LEVEL>]	Test tone ^{b)} [TEST TONE]	OFF, AUTO ■■■■ ^{c)} , FIX ■■■■ ^{c)}
	Front left speaker level ^{b)} [FL LEVEL]	FL -10.0 dB to FL +10.0 dB (0.5 dB interval)
	Front right speaker level ^{b)} [FR LEVEL]	FR -10.0 dB to FR +10.0 dB (0.5 dB interval)
	Center speaker level ^{b)} [CNT LEVEL]	CNT -10.0 dB to CNT +10.0 dB (0.5 dB interval)
	Surround left speaker level ^{b)} [SL LEVEL]	SL -10.0 dB to SL +10.0 dB (0.5 dB interval)
	Surround right speaker level ^{b)} [SR LEVEL]	SR -10.0 dB to SR +10.0 dB (0.5 dB interval)
	Surround back speaker level ^{b)} [SB LEVEL]	SB -10.0 dB to SB +10.0 dB (0.5 dB interval)
	Surround back left speaker level ^{b)} [SBL LEVEL]	SBL -10.0 dB to SBL +10.0 dB (0.5 dB interval)
	Surround back right speaker level ^{b)} [SBR LEVEL]	SBR -10.0 dB to SBR +10.0 dB (0.5 dB interval)
	Front high left speaker level ^{b)} [LH LEVEL]	LH -10.0 dB to LH +10.0 dB (0.5 dB interval)
	Front high right speaker level ^{b)} [RH LEVEL]	RH -10.0 dB to RH +10.0 dB (0.5 dB interval)
	Subwoofer level ^{b)} [SW LEVEL]	SW -10.0 dB to SW +10.0 dB (0.5 dB interval)

Menu [Display]	Parameters [Display]	Settings
Speaker settings [<SPEAKER>]	Speaker pattern [SP PATTERN]	5/2.1 to 2/0 (20 patterns)
	Center speaker lift up ^{b)} [CNT LIFT]	LIFT 1 to LIFT 10, LIFT OFF
	Front speakers size ^{b)} [FRT SIZE]	LARGE, SMALL
	Center speaker size ^{b)} [CNT SIZE]	LARGE, SMALL
	Surround speakers size ^{b)} [SUR SIZE]	LARGE, SMALL
	Front high speakers size ^{b)} [FH SIZE]	LARGE, SMALL
	Surround back speaker assign ^{d)} [SB ASSIGN]	SPK B, BI-AMP, OFF
	Front left speaker distance ^{b)} [FL DIST.]	FL 1.00 m to FL 10.00 m (FL 3'3" to FL 32'9") (0.01 m (1 inch) interval)
	Front right speaker distance ^{b)} [FR DIST.]	FR 1.00 m to FR 10.00 m (FR 3'3" to FR 32'9") (0.01 m (1 inch) interval)
	Center speaker distance ^{b)} [CNT DIST.]	CNT 1.00 m to CNT 10.00 m (CNT 3'3" to CNT 32'9") (0.01 m (1 inch) interval)
	Surround left speaker distance ^{b)} [SL DIST.]	SL 1.00 m to SL 10.00 m (SL 3'3" to SL 32'9") (0.01 m (1 inch) interval)
	Surround right speaker distance ^{b)} [SR DIST.]	SR 1.00 m to SR 10.00 m (SR 3'3" to SR 32'9") (0.01 m (1 inch) interval)
	Surround back speaker distance ^{b)} [SB DIST.]	SB 1.00 m to SB 10.00 m (SB 3'3" to SB 32'9") (0.01 m (1 inch) interval)
	Surround back left speaker distance ^{b)} [SBL DIST.]	SBL 1.00 m to SBL 10.00 m (SBL 3'3" to SBL 32'9") (0.01 m (1 inch) interval)
	Surround back right speaker distance ^{b)} [SBR DIST.]	SBR 1.00 m to SBR 10.00 m (SBR 3'3" to SBR 32'9") (0.01 m (1 inch) interval)
Front high left speaker distance ^{b)} [LH DIST.]	LH 1.00 m to LH 10.00 m (LH 3'3" to LH 32'9") (0.01 m (1 inch) interval)	

Menu [Display]	Parameters [Display]	Settings
	Front high right speaker distance ^{b)} [RH DIST.]	RH 1.00 m to RH 10.00 m (RH 3'3" to RH 32'9") (0.01 m (1 inch) interval)
	Subwoofer distance ^{b)} [SW DIST.]	SW 1.00 m to SW 10.00 m (SW 3'3" to SW 32'9") (0.01 m (1 inch) interval)
	Distance unit [DIST. UNIT]	FEET, METER
	Front speakers crossover frequency ^{e)} [FRT CROSS]	CROSS 40 Hz to CROSS 200 Hz (10 Hz interval)
	Center speaker crossover frequency ^{e)} [CNT CROSS]	CROSS 40 Hz to CROSS 200 Hz (10 Hz interval)
	Surround speakers crossover frequency ^{e)} [SUR CROSS]	CROSS 40 Hz to CROSS 200 Hz (10 Hz interval)
	Front high speakers crossover frequency ^{e)} [FH CROSS]	CROSS 40 Hz to CROSS 200 Hz (10 Hz interval)
Input settings [<INPUT>]	Input mode [INPUT MODE]	AUTO, OPT, COAX, ANALOG
	Naming inputs [NAME IN]	For details, see "Name" in Input Settings menu (page 100).
	Digital audio input assignment [A. ASSIGN]	OPT 1, OPT 2, COAX, NONE
	Component video input assignment [V. ASSIGN]	COMP 1, COMP 2, NONE
Surround settings [<SURROUND>]	Effect level ^{f)} [HD-D.C.S. TYP]	DYNAMIC, THEATER, STUDIO
EQ settings [<EQ>]	Front speakers bass level [FRT BASS]	FRT B. -10 dB to FRT B. +10 dB (1 dB step)
	Front speakers treble level [FRT TREBLE]	FRT T. -10 dB to FRT T. +10 dB (1 dB step)
	Center speaker bass level [CNT BASS]	CNT B. -10 dB to CNT B. +10 dB (1 dB step)
	Center speaker treble level [CNT TREBLE]	CNT T. -10 dB to CNT T. +10 dB (1 dB step)
	Surround speakers bass level [SUR BASS]	SUR B. -10 dB to SUR B. +10 dB (1 dB step)
	Surround speakers treble level [SUR TREBLE]	SUR T. -10 dB to SUR T. +10 dB (1 dB step)

Menu [Display]	Parameters [Display]	Settings
	Front high speakers bass level [FH BASS]	FH B. -10 dB to FH B. +10 dB (1 dB step)
	Front high speakers treble level [FH TREBLE]	FH T. -10 dB to FH T. +10 dB (1 dB step)
Tuner settings [<TUNER>]	FM station receiving mode [FM MODE]	STEREO, MONO
	Naming preset stations [NAME IN]	For details, see “To name preset stations (Name Input)” (page 54).
Audio settings [<AUDIO>]	Digital Legato Linear [D.L.L.]	D.L.L. AUTO2, D.L.L. AUTO1, D.L.L. OFF
	Sound Optimizer [OPTIMIZER]	OFF, LOW, NORMAL
	Synchronizes audio with video output [A/V SYNC]	HDMI AUTO, 0 ms to 300 ms (10 ms interval)
	Advanced Auto Volume [AUTO VOL]	A. VOL ON, A. VOL OFF
	Digital broadcast language selection [DUAL MONO]	MAIN/SUB, MAIN, SUB
	Dynamic range compressor [D. RANGE]	COMP. ON, COMP. AUTO, COMP. OFF
HDMI settings [<HDMI>]	4K Scaling [4K SCALING]	AUTO, OFF
	Control for HDMI [CTRL: HDMI]	CTRL ON, CTRL OFF
	Pass Through [PASS THRU]	ON, AUTO, OFF
	Audio Out [AUDIO OUT]	AMP, TV+AMP
	HDMI subwoofer level [SW LEVEL]	SW AUTO, SW +10 dB, SW 0 dB
	Fast View [FAST VIEW]	AUTO, OFF
Bluetooth settings [<BT>]	Bluetooth standby mode ^{g)} [BT STANDBY]	STBY ON, STBY OFF
	Bluetooth AAC [BT AAC]	AAC ON, AAC OFF

Menu [Display]	Parameters [Display]	Settings
System settings [<SYSTEM>]	Network standby [NET STBY]	STBY ON, STBY OFF
	Auto standby mode [AUTO STBY]	STBY ON, STBY OFF
	Version display [VER. x.xxx] ^{h)}	

- a) You can select this setting only when you have performed the Auto Calibration and saved the settings.
 b) Depends on the speaker pattern setting, some parameters or settings may not be available.
 c) ■■■ represent a speaker channel (FL, FR, CNT, SL, SR, SB, SBL, SBR, LH, RH, SW).
 d) You can only select this parameter if "SP PATTERN" is not set to a setting with surround back or front high speakers (page 95).
 e) You can only select this parameter if your speaker is set to "SMALL".
 f) You can only select this parameter if you select "HD-D.C.S." as sound field.
 g) You can only select this parameter when a *Bluetooth* device is paired.
 h) x.xxx represent a version number.

To view the information on the display panel

The display panel provides various information of the receiver status such as sound field.

- 1 Select the input for which you want to check the information.
- 2 Press AMP, then press DISPLAY repeatedly.

Each time you press DISPLAY, the display will change cyclically as follows.

Index name of the input¹⁾ → Input you selected → Sound field currently applied²⁾ → Volume level → Stream information³⁾

When listening to FM and AM radio

Preset station name¹⁾ → Frequency → Sound field currently applied²⁾ → Volume level

- ¹⁾ Index name appears only when you have assigned one to the input or preset station. Index name does not appear when only blank spaces have been entered or it is same as the input name.

- ²⁾ "PURE.DIRECT" appears when Pure Direct function is activated.
³⁾ Stream information may not be displayed.

Note

Character or marks may not be displayed for some languages.

Using the Remote Control

Programming the remote control

You can customize the remote control to match the equipment connected to your receiver. You can even program the remote control to operate non-Sony equipment and also Sony equipment that the remote control is normally unable to operate. Before you begin, note that:

- You cannot change the settings of TUNER, BLUETOOTH, USB, HOME NETWORK, SEN, and SOURCE input buttons.
- The remote control can only control equipment that accept infrared wireless control signals.

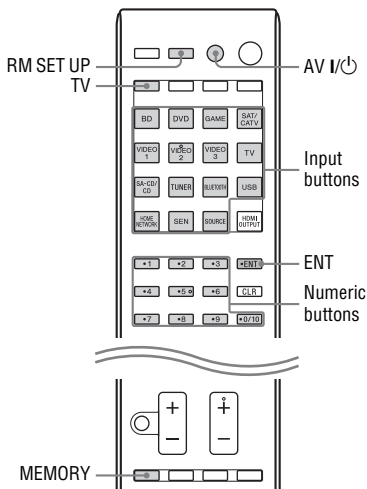

- 1 Hold down RM SET UP, then press AV I/⏻.**
The RM SET UP button flashes slowly.

- 2 Press the input button of the equipment you want to program.**
For example, if you want to program a VCR connected to VIDEO 1 jacks, press VIDEO 1.
The RM SET UP button lights up.

- 3 Press the numeric buttons to enter the numeric code.**
If more than one code exists, try to enter either one which corresponds to the equipment including TV.
Use the tables on page 109–112 to find the numeric code(s) corresponding to the equipment.

Note

Only the codes in the 500's are valid for the TV button.

- 4 Press ENT.**
Once the numeric code has been verified, the RM SET UP button slowly flashes twice and the remote control automatically exits the programming mode.

- 5 Repeat steps 1 to 4 to program other equipment.**

Note

The RM SET UP button turns off while a numeric button is pressed.

To cancel programming

Press RM SET UP during any step. The remote control automatically exits the programming mode.

To activate the input after programming

Press the programmed button to activate the input you want.

If programming is unsuccessful, check the following:

- If the RM SET UP button does not light up in step 1, the batteries are weak. Replace both batteries.

- If the RM SET UP button flashes 5 times in quick succession while entering the numeric code, an error has occurred. Start again from step 1.

The numeric codes corresponding to the equipment and the maker of the equipment

Use the numeric codes in the tables below to program non-Sony equipment and also Sony equipment that the remote control is normally unable to control. Since the signal from the remote control received by the equipment differs by its model and the year, more than one numeric code may be assigned to the equipment. If you fail to program your remote control using one of the codes, try using other codes.

Notes

- The numeric codes are based on the latest information available for each brand. There is a chance, however, that your equipment will not respond to some or all of the codes.
- All of the input buttons on this remote control may not be available when used with your particular equipment.

To control a CD player

Maker	Code(s)
SONY	101, 102, 103
DENON	104, 123
JVC	105, 106, 107
KENWOOD	108, 109, 110
MAGNAVOX	111, 116
MARANTZ	116
ONKYO	112, 113, 114
PANASONIC	115
PHILIPS	116
PIONEER	117
TECHNICS	115, 118, 119
YAMAHA	120, 121, 122

To control a DAT deck

Maker	Code(s)
SONY	203
PIONEER	219

To control a tape deck

Maker	Code(s)
SONY	201, 202
DENON	204, 205
KENWOOD	206, 207, 208, 209
NAKAMICHI	210
PANASONIC	216
PHILIPS	211, 212
PIONEER	213, 214
TECHNICS	215, 216
YAMAHA	217, 218

To control an MD deck

Maker	Code(s)
SONY	301
DENON	302
JVC	303
KENWOOD	304

To control an HDD recorder

Maker	Code(s)
SONY	307, 308, 309

To control a Blu-ray Disc player/recorder

Maker	Code(s)
SONY	310, 311, 312
PANASONIC	335
SAMSUNG	336
LG	337

To control a PSX

Maker	Code(s)
SONY	313, 314, 315

To control a DVD player

Maker	Code(s)
SONY	401, 402, 403
BROKSONIC	424
DENON	405
HITACHI	416
JVC	415, 423
MINISUBISHI	419
ORITRON	417
PANASONIC	406, 408, 425
PHILIPS	407
PIONEER	409, 410
RCA	414
SAMSUNG	416, 422
TOSHIBA	404, 421
ZENITH	418, 420

To control a DVD recorder

Maker	Code(s)
SONY	401, 402, 403

To control a DVD/VCR COMBO

Maker	Code(s)
SONY	411

To control a DVD/HDD COMBO

Maker	Code(s)
SONY	401, 402, 403

To control a TV

Maker	Code(s)
SONY	501, 502

Maker	Code(s)
AIWA	501, 536, 539
AKAI	503
AOC	503
CENTURION	566
CORONADO	517
CURTIS-MATHES	503, 551, 566, 567
DAYTRON	517, 566
DAEWOO	504, 505, 506, 507, 515, 544
FISHER	508, 545
FUNAI	548
FUJITSU	528
GOLDSTAR/LG	503, 512, 515, 517, 534, 544, 556, 568
GRUNDIG	511, 533, 534
HITACHI	503, 513, 514, 515, 517, 519, 544, 557, 571
ITT/NOKIA	521, 522
J.C.PENNY	503, 510, 566
JVC	516, 552
KMC	517
MAGNAVOX	503, 515, 517, 518, 544, 566
MARANTZ	527
MINISUBISHI/MGA	503, 519, 527, 544, 566, 568
NEC	503, 517, 520, 540, 544, 554, 566
NORDMENDE	530, 558
NOKIA	521, 522, 573, 575
PANASONIC	509, 524, 553, 559, 572
PHILIPS	515, 518, 557, 570, 571
PHILCO	503, 504, 514, 517, 518
PIONEER	509, 525, 526, 540, 551, 555

Maker	Code(s)
PORTLAND	503
QUASAR	509, 535
RADIO SHACK	503, 510, 527, 565, 567
RCA/PROSCAN	503, 510, 523, 529, 544
SAMSUNG	503, 515, 517, 531, 532, 534, 544, 556, 557, 562, 563, 566, 569
SAMPO	566
SABA	530, 537, 547, 549, 558
SANYO	508, 545, 546, 560, 567
SCOTT	503, 566
SEARS	503, 508, 510, 517, 518, 551
SHARP	517, 535, 550, 561, 565
SYLVANIA	503, 518, 566
THOMSON	530, 537, 547, 549
TOSHIBA	535, 539, 540, 541, 551
TELEFUNKEN	530, 537, 538, 547, 549, 558
TEKNIKA	517, 518, 567
WARDS	503, 517, 566
YORK	566
ZENITH	542, 543, 567
GE	503, 509, 510, 544
LOEWE	515, 534, 556
VIZIO	576, 577

To control an LD player

Maker	Code(s)
SONY	601, 602, 603
PIONEER	606

To control a Video CD player

Maker	Code(s)
SONY	605

To control a VCR

Maker	Code(s)
SONY	701, 702, 703, 704, 705, 706
AIWA*	710, 750, 757, 758
BLAUPUNKT	740
EMERSON	750
FISHER	717, 720
GENERAL ELECTRIC (GE)	722, 730
GOLDSTAR/LG	723, 753
HITACHI	722, 725, 729, 741
ITT/NOKIA	717
JVC	726, 727, 728, 736
MAGNAVOX	730, 731, 738
MITSUBISHI/MGA	732, 733, 734, 735
NEC	736
PANASONIC	729, 730, 737, 738, 739, 740
PHILIPS	729, 730, 731
PIONEER	729
RCA/PROSCAN	722, 729, 730, 731, 741, 747
SAMSUNG	742, 743, 744, 745
SANYO	717, 720, 746
SHARP	748, 749
TOSHIBA	747, 756

* If an AIWA VCR does not work even though you enter the code for AIWA, enter the code for Sony instead.

To control a satellite tuner (box)

Maker	Code(s)
SONY	801, 802, 803, 804, 824, 825, 865
AMSTRAD	845, 846
BskyB	862
GENERAL ELECTRIC (GE)	866
GRUNDIG	859, 860
HUMAX	846, 847
THOMSON	857, 861, 864, 876
PACE	848, 849, 850, 852, 862, 863, 864
PANASONIC	818, 855
PHILIPS	856, 857, 858, 859, 860, 864, 874
NOKIA	851, 853, 854, 864
RCA/PROSCAN	866, 871
BITA/HITACHI	868
HUGHES	867
JVC/Echostar/Dish Network	873
MITSUBISHI	872
SAMSUNG	875
TOSHIBA	869, 870



To control a cable box

Maker	Code(s)
SONY	821, 822, 823
HAMLIN/REGAL	836, 837, 838, 839, 840
JERROLD/G.I./MOTOROLA	806, 807, 808, 809, 810, 811, 812, 813, 814, 819
JERROLD	830, 831
OAK	841, 842, 843
PANASONIC	816, 826, 832, 833, 834, 835

Maker	Code(s)
PHILIPS	830, 831
PIONEER	828, 829
RCA	805
SCIENTIFIC ATLANTA	815, 816, 817, 844
TOCOM/PHILIPS	830, 831
ZENITH	826, 827

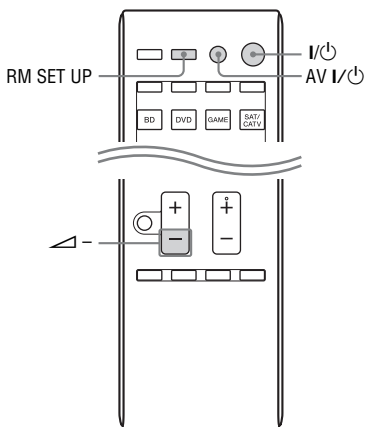
Resetting the remote control



- 1 While holding down , press and hold , then press . The RM SET UP button flashes 3 times.
- 2 Release all buttons. All the contents of the remote control memory (i.e., all the programmed data) are cleared.

Additional Information

Precautions

On safety

Should any solid object or liquid fall into the cabinet, unplug the receiver and have it checked by qualified personnel before operating it any further.

On power sources

- Before operating the receiver, check that the operating voltage is identical with your local power supply.

The operating voltage is indicated on the nameplate on the back of the receiver.

- The unit is not disconnected from the AC power source (mains) as long as it is connected to the wall outlet, even if the unit itself has been turned off.
- If you are not going to use the receiver for a long time, be sure to disconnect the receiver from the wall outlet. To disconnect the AC power cord (mains lead), grasp the plug itself; never pull the cord.
- (USA and Canada models only)
One blade of the plug is wider than the other for the purpose of safety and will fit into the wall outlet only one way. If you are unable to insert the plug fully into the outlet, contact your dealer.
- The AC power cord (mains lead) must be changed only at a qualified service shop.

On heat buildup

Although the receiver heats up during operation, this is not a malfunction. If you continuously use this receiver at a large volume, the cabinet temperature of the top, side and bottom rises considerably. To avoid burning yourself, do not touch the cabinet.

On placement

- Place the receiver in a location with adequate ventilation to prevent heat buildup and prolong the life of the receiver.
- Do not place the receiver near heat sources, or in a place subject to direct sunlight, excessive dust, or mechanical shock.
- Do not place anything on top of the cabinet that might block the ventilation holes and cause malfunctions.
- Do not place the receiver near equipment such as a TV, VCR, or tape deck. (If the receiver is being used in combination with a TV, VCR, or tape deck, and is placed too close to that equipment, noise may result, and picture quality may suffer. This is especially likely when using an indoor antenna (aerial). Therefore, we recommend using an outdoor antenna (aerial).)
- Use caution when placing the receiver on surfaces that have been specially treated (with wax, oil, polish, etc.) as staining or discoloration of the surface may result.

On operation

Before connecting other equipment, be sure to turn off and unplug the receiver.

On cleaning

Clean the cabinet, panel, and controls with a soft cloth slightly moistened with a mild detergent solution. Do not use any type of abrasive pad, scouring powder, or solvent, such as alcohol or benzene.

On Bluetooth communication

- *Bluetooth* devices should be used within approximately 10 meters (33 feet) (unobstructed distance) of each other. The effective communication range may become shorter under the following conditions.

- When a person, metal object, wall or other obstruction is between the devices with a *Bluetooth* connection
- Locations where a wireless LAN is installed
- Around microwave ovens that are in use
- Locations where other electromagnetic waves occur
- *Bluetooth* devices and wireless LAN (IEEE 802.11b/g) use the same frequency band (2.4 GHz). When using your *Bluetooth* device near a device with wireless LAN capability, electromagnetic interference may occur. This could result in lower data transfer rates, noise, or inability to connect. If this happens, try the following remedies:
 - Use this receiver at least 10 meters (33 feet) away from the wireless LAN device.
 - Turn off the power to the wireless LAN equipment when using your *Bluetooth* device within 10 meters (33 feet).
 - Install this receiver and *Bluetooth* device as closer to each other as possible.
- The radio waves broadcast by this receiver may interfere with the operation of some medical devices. Since this interference may result in malfunction, always turn off the power on this receiver and *Bluetooth* device in the following locations:
 - In hospitals, on trains, in airplanes, at gas stations, and any place where flammable gasses may be present
 - Near automatic doors or fire alarms
- This receiver supports security functions that comply with the *Bluetooth* specification to ensure secure connection during communication using *Bluetooth* technology. However, this security may be insufficient depending on the setting contents and other factors, so always be careful when performing communication using *Bluetooth* technology.
- Sony cannot be held liable in any way for damages or other loss resulting from information leaks during communication using *Bluetooth* technology.
- *Bluetooth* communication is not necessarily guaranteed with all *Bluetooth* devices that have the same profile as this receiver.
- *Bluetooth* devices connected with this receiver must comply with the *Bluetooth* specification prescribed by the Bluetooth SIG, Inc., and must be certified to comply. However, even when a device complies with the *Bluetooth* specification, there may be cases where the characteristics or specifications of the *Bluetooth* device make it impossible to connect, or may result in different control methods, display or operation.
- Noise may occur or the audio may cut off depending on the *Bluetooth* device connected with this receiver, the communications environment, or surrounding conditions.

If you have any questions or problems concerning your receiver, please consult your nearest Sony dealer.

Troubleshooting

If you experience any of the following difficulties while using the receiver, use this troubleshooting guide to help you remedy the problem. Should any problem persist, consult your nearest Sony dealer. Note that if service personnel changes some parts during repair, these parts may be retained.

Power

The receiver is turned off automatically.

- “Auto Standby” is set to “On” (page 102).
- The Sleep Timer function is working (page 16).
- “PROTECTOR” is working (page 126).

Image

No image appears on the TV.

- Select the appropriate input using the input buttons.
- Set your TV to the appropriate input mode.
- Move your audio equipment away from the TV.
- Assign the component video input correctly.
- The input signal should be same as the input function when you are up-converting an input signal with this receiver (page 22).
- Make sure that cables are correctly and securely connected to equipment.
- Depending on the playback equipment, you may need to set up the equipment. Refer to the operating instructions supplied with each equipment.

- Be sure to use a High Speed HDMI cable when you view images or listen to sound, especially for the 1080p, Deep Color (Deep Colour), 4K or 3D transmission.
- The output of the HDMI video signals of the receiver may be set to “HDMI OFF”. In this case, select “HDMI A” or “HDMI B” using the HDMI OUTPUT button (page 85).

No 3D image appears on the TV.

- Depending on the TV or the video equipment, 3D images may not be displayed. Check the HDMI video formats supported by the receiver (page 129).

No 4K image appears on the TV.

- Depending on the TV or the video equipment, 4K images may not be displayed. Check the video capability and setting of your TV and video equipment. Also, make sure you connect the video equipment to 4K available HDMI IN jack of this receiver.

When the receiver is in standby mode, there is no image output from the TV.

- When the receiver enters into standby mode, image is from the last HDMI equipment selection before you turned off the receiver. If you are enjoying other equipment, play the equipment and perform the One-Touch Play operation, or turn on the receiver to select the HDMI equipment you want to enjoy.
- Make sure “Pass Through” is set to “On” in the HDMI Settings menu if you connect equipment not compatible with the “BRAVIA” Sync to the receiver (page 99).

The GUI menu does not appear on the TV screen.

- GUI is only available when you connect to the HDMI OUT A or HDMI OUT B jacks.
- Press HOME to turn the GUI on.

- Check that the TV is connected correctly.
- Depending on the TV, the GUI menu may take some time to appear on the TV screen.

Display panel is turned off.

- If PURE DIRECT indicator on the front panel lights up, press PURE DIRECT to turn off the function (page 59).
- Press DIMMER on the receiver to adjust the brightness of the display panel.

Sound

There is no sound, no matter which equipment is selected, or only a very low-level sound is heard.

- Check that all connecting cords are inserted to their input/output jacks for the respective jacks of the receiver, speakers and the equipment.
- Check that both the receiver and all equipment are turned on.
- Check that MASTER VOLUME control is not set to “VOL MIN”.
- Check that the SPEAKERS is not set to “SPK OFF” (page 39).
- Check that headphones are not connected to the receiver.
- Press  to cancel the muting function.
- Try pressing the input button on the remote control or turning the INPUT SELECTOR on the receiver to select the equipment of your choice (page 45).
- When you want to listen to the sound from the TV speaker, set the “Audio Out” to “TV+AMP” in the HDMI Settings menu (page 99). If you cannot play back multi channel audio source, set to “AMP”. However, the sound will not output through the TV speaker.

- Sound may be interrupted when the sampling frequency, the number of channels or audio format of audio output signals from the playback equipment is switched.

There is severe hum or noise.

- Check that the speakers and equipment are connected securely.
- Check that the connecting cords are away from a transformer or motor, and at least 3 meters (10 feet) away from a TV set or fluorescent light.
- Move your audio equipment away from the TV.
- The plugs and jacks are dirty. Wipe them with a cloth slightly moistened with alcohol.

There is no sound, or only a very low-level sound is heard from specific speakers.

- Connect a pair of headphones to the PHONES jack to verify that sound is output from the headphones. If only one channel is output from the headphones, the equipment may not be connected to the receiver correctly. Check that all the cords are fully inserted into the jacks on both the receiver and the equipment. If both channels are output from the headphones, the front speaker may not be connected to the receiver correctly. Check the connection of the front speaker which is not outputting any sound.
- Make sure you have connected to both the L and R jacks of an analog equipment, analog equipment requires both L and R jack connections. Use an audio cord (not supplied).
- Adjust the speaker level (page 95).
- Check that the speaker settings are appropriate for the setup using “Auto Calibration” or “Speaker Connection” in the Speaker Settings menu. Then check that sound is output from each speaker correctly, using “Test Tone” in the Speaker Settings menu.

- Some discs have no Dolby Digital Surround EX information.
- Check that the subwoofer is connected correctly and securely.
- Make sure you have turned on your subwoofer.
- Depending on the selected sound field, no sound will be available from the subwoofer.
- When all speakers are set to “Large” and “Neo:6 Cinema” or “Neo:6 Music” is selected, there is no sound from the subwoofer.

There is no sound from a specific equipment.

- Check that the equipment is connected correctly to the audio input jacks for that equipment.
- Check that the cord(s) used for the connection is (are) fully inserted into the jacks on both the receiver and the equipment.
- Check the INPUT MODE (page 86).
- Check that the equipment is connected correctly to the HDMI jack for that equipment.
- Depending on the playback equipment, you may need to set up the HDMI setting of the equipment. Refer to the operating instructions supplied with each equipment.
- Be sure to use a High Speed HDMI cable when you view images or listen to sound, especially for the 1080p, Deep Color (Deep Colour), 4K or 3D transmission.
- Sound may not be output from the receiver while the GUI appears on the TV screen. Press HOME to turn the GUI off.
- Audio signals (format, sampling frequency, bit length, etc.) transmitted from an HDMI jack may be suppressed by the connected equipment. Check the setup of the connected equipment if the image is poor or the sound does not come out of the equipment connected via the HDMI cable.
- When the connected equipment is not compatible with copyright protection technology (HDCP), the image and/or the sound from the HDMI OUT jack may be distorted or may not be output. If this is the case, check the specification of the connected equipment.
- Set the image resolution of the playback equipment to more than 720p/1080i to enjoy High Bitrate Audio (DTS-HD Master Audio, Dolby TrueHD).
- The image resolution of the playback equipment may need to be at certain settings before you can enjoy DSD and Multi Channel Linear PCM. Refer to the operating instructions of the playback equipment.
- Make sure the TV is compatible with the System Audio Control function.
- If the TV does not have System Audio Control function, set the “Audio Out” settings in HDMI Settings menu to
 - “TV+AMP” if you want to listen to the sound from the TV speaker and receiver.
 - “AMP” if you want to listen to the sound from the receiver.
- When you connect the receiver to a video equipment (projector, etc.), sound may not be output from the receiver. In this case, set the “Audio Out” to “AMP” in the HDMI Settings menu (page 99).
- You cannot listen to the sound of the equipment connected to the receiver while TV input is selected on the receiver
 - Be sure to change the input of the receiver to HDMI when you want to watch a program on the equipment connected via HDMI connection to the receiver.
 - Change the TV channel when you want to watch a TV broadcast.

- Be sure to select the correct equipment or input you want when you watch a program from the equipment connected to the TV. Refer to the operating instructions of the TV on this operation.
- When “2ch Analog Direct” is being used, the sound is not output. Use other sound field (page 55).
- When using the Control for HDMI function, you cannot control the connected equipment using TV’s remote control.
 - Depending on the connected equipment and TV, you may need to set up the equipment and TV. Refer to the operating instructions supplied with each equipment and TV.
 - Change the input of the receiver to the HDMI input connected to the equipment.
- Check that the selected digital audio input jack is not assigned to other inputs (page 86).

The left and right sounds are unbalanced or reversed.

- Check that the speakers and equipment are connected correctly and securely.
- Adjust the sound level parameters using the Speaker Settings menu.

Dolby Digital or DTS multi channel sound is not reproduced.

- Check that the DVD, etc. you are playing is recorded in Dolby Digital or DTS format.
- When connecting the DVD player, etc., to the digital input jacks of this receiver, make sure the digital audio output setting of the connected equipment is available.
- Set “Audio Out” to “AMP” in the HDMI Settings menu (page 99).
- You can enjoy High Bitrate Audio (DTS-HD Master Audio, Dolby TrueHD), DSD and Multi Channel Linear PCM with an HDMI connection only.

The surround effect cannot be obtained.

- Make sure you have selected the sound field for movie or music (page 55).
- Sound fields do not function when DTS-HD Master Audio, DTS-HD High Resolution Audio or Dolby TrueHD with sampling frequency of more than 48 kHz are being received.

A test tone is not output from the speakers.

- The speaker cords may not be connected securely. Check to see if they are connected securely and cannot be disconnected by pulling on them slightly.
- The speaker cords may have short-circuit problem.
- Make sure that you are not using PARTY STREAMING function (page 72).

A test tone is output from a different speaker than the speaker displayed on the TV screen.

- The speaker pattern set up is incorrect. Make sure that the speaker connections and the speaker pattern match correctly.

When the receiver is in standby mode, there is no sound output from the TV.

- When the receiver enters into standby mode, sound is from the last HDMI equipment selection before you turned off the receiver. If you are enjoying other equipment, play the equipment and perform the One-Touch Play operation, or turn on the receiver to select the HDMI equipment you want to enjoy.
- Make sure “Pass Through” is set to “On” in the HDMI Settings menu if you connect equipment not compatible with the “BRAVIA” Sync to the receiver (page 99).

There is a time gap between the audio output and visual display.

- Check that the PARTY STREAMING function is not being used. To close a PARTY, press PARTY CLOSE until “CLOSE PARTY” appears. For details, see page 73.
-

Tuner

The FM reception is poor.

- Use a 75-ohm coaxial cable (not supplied) to connect the receiver to an outdoor FM antenna (aerial) as shown below.

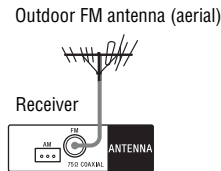
**Radio stations cannot be tuned in.**

- Check that the antennas (aerials) are connected securely. Adjust the antennas (aerials) and connect an external antenna (aerial), if necessary.
 - The signal strength of the stations is too weak with automatic tuning. Use direct tuning.
 - Make sure you set the tuning scale correctly (when tuning in AM stations with direct tuning) (page 53).
 - No stations have been preset or the preset stations have been cleared (when tuning by scanning preset stations is used). Preset the stations (page 54).
 - Press AMP, then press DISPLAY repeatedly on the remote control so that the frequency appears on the display panel.
-

iPod/iPhone

The sound is distorted.

- Press \triangleleft – on the remote control repeatedly. You can also use MASTER VOLUME on the receiver.
 - Set the “EQ” setting of the iPod/iPhone to “Off” or “Flat”.
-

There is no sound from the iPod/iPhone.

- Disconnect the iPod/iPhone and connect the iPod/iPhone again.
-

The iPod/iPhone cannot be charged.

- Check that the receiver is turned on.
 - Make sure the iPod/iPhone is connected firmly.
-

The iPod/iPhone cannot be operated.

- Check that you have removed the protect case of the iPod/iPhone.
 - Depending on the contents of the iPod/iPhone, it may take time to start playback.
 - Turn off the receiver, then disconnect the iPod/iPhone. Turn on the receiver again and reconnect the iPod/iPhone.
 - You are using an unsupported iPod/iPhone. See “Compatible iPod/iPhone models” (page 47) for the supported device types.
-

The ringtones volume of the iPhone does not change.

- Adjust the ring volume using the controls on the iPhone.
-

USB device

Are you using a supported USB device?

- If you connect an unsupported USB device, the following problems may occur. See “Compatible USB devices” (page 49) for the supported device types.

- The USB device is not recognized.
- File or folder names are not displayed on this receiver.
- Playback is not possible.
- The sound skips.
- There is noise.
- A distorted sound is output.

There is noise, skipping, or distorted sound.

- Turn off the receiver and reconnect the USB device, then turn on the receiver.
- The music data itself contains noise, or the sound is distorted.

The USB device is not recognized.

- Turn off the receiver, then disconnect the USB device. Turn on the receiver again and reconnect the USB device.
- Connect the supported USB device (page 49).
- The USB device does not work properly. Refer to the USB device operating instructions on how to deal with this problem.

Playback does not start.

- Turn off the receiver and reconnect the USB device, then turn on the receiver.
- Connect the supported USB device (page 49).
- Press ► to start playback.

The USB device cannot be connected into the Ψ (USB) port.

- The USB device is being connected upside down. Connect the USB device in the correct orientation.

Erroneous display.

- The data stored in the USB device may have been corrupted.
- The character codes that can be displayed by this receiver are as follows:
 - Upper cases (A to Z)
 - Lower cases (a to z)
 - Numbers (0 to 9)
 - Symbols (' = < > * + , - . / @ [\] _ `)Other characters may not be displayed correctly.

“Reading” is displayed for an extended time, or it takes a long time before playback starts.

- The reading process can take a long time in the following cases.
 - There are many folders or files on the USB device.
 - The file structure is extremely complex.
 - The memory capacity is excessive.
 - The internal memory is fragmented.Thus, we recommend following these guidelines.
 - Total folders on USB device: 256 or less (including “ROOT” folder)
 - Total files per folder: 256 or less.

Audio file cannot be played back.

- MP3 files in MP3 PRO format cannot be played back.
- The audio file is a multiple track audio file.
- Some AAC files may not be played back correctly.
- WMA files in Windows Media Audio Lossless and Professional format cannot be played back.
- USB device formatted with file systems other than FAT16 or FAT32 are unsupported.*
- If you use partitioned USB device, only audio files on the first partition can be played back.
- Playback is possible up to 8 levels (including “ROOT” folder).
- The number of folders has exceeded 256 (including “ROOT” folder).
- The number of files in a folder has exceeded 256.
- Files that are encrypted or protected by passwords, etc. cannot be played back.

* This unit supports FAT16 and FAT32, but some USB device may not support all of these FAT. For details, refer to the operating instructions of each USB device or contact the manufacturer.

Network connection

Cannot connect to the WPS via a wireless LAN connection.

- You cannot connect to a network using WPS when your access point is set to WEP. Set up your network after searching the access point using the access point scan.

An error message appears.

- Check the nature of the error. See “Network features message list” (page 76).

Cannot connect to the network.

- Check the network status. See “Connection Status” in “Information” in Network Settings menu (page 101). If “Not connected” appears, set up the network connection again (page 39).
- When the system is connected through a wireless network, move the receiver and the wireless LAN router/access point closer to each other and do the setup again.
- Check the settings of the wireless LAN router/access point and do the setup again. For details on the settings of the devices, refer to the operating instructions of the devices.
- Make sure that you use a wireless LAN router/access point.
- Wireless networks are influenced by electromagnetic radiation emitted by microwave ovens and other devices. Move the unit away from these devices.
- Make sure that the wireless LAN router/access point is turned on.

Cannot control the receiver using the TV SideView device.

- The receiver may take a long time to connect to the network after you turn on the receiver. Wait for a few moments, and then try using the TV SideView again.

- Make sure “Network Standby” is set to “On” in the Network Settings menu so that you can use the TV SideView immediately after you have turned on the receiver.

Cannot select the Network Settings menu.

- Wait for a few moments after you turned on the receiver, and then select the Network Settings menu again.

Home Network

Cannot connect to the network.

- Make sure the wireless LAN router/access point is turned on.
- Make sure the server is turned on.
- The network settings on the receiver may be incorrect. Check the network status. See “Connection Status” in “Information” in Network Settings menu (page 101). If “Not connected” appears, set up the network connection again (page 39).
- The server may be unstable. Restart it.
- Confirm that the receiver and the server are connected to the wireless LAN router/access point correctly.
- Confirm that the server has been set correctly (page 61). Confirm that the receiver has been registered to the server and allows the music streaming from the server.
- When the system is connected to the wireless network, move the receiver and the wireless LAN router/access point closer to each other.

- If the ICF (Internet Connection Firewall) function is active on the computer, this may prevent the receiver from connecting to the computer (only when your computer is used as a server). You may need to change the firewall settings to allow the receiver to connect. (For details on changing the firewall settings, refer to the operating instructions supplied with your computer.)
- If you have initialized the receiver or performed a system recovery on your server, perform the network settings again (page 39).

The server (such as a computer) does not appear in the server list. (“No server is available” appears on the TV screen.)

- You may have turned on this receiver before you turned on the server. Refresh the server list (page 66).
- Make sure that the wireless LAN router/access point is turned on.
- Make sure that the server is turned on.
- Confirm that the server has been set correctly (page 61). Confirm that the receiver has been registered to the server and allows the music streaming from the server.
- Confirm that the receiver and the server are connected to the wireless LAN router/access point correctly. Check the network setting information (page 101).
- Refer to the operating instructions of your wireless LAN router/access point, and check the multicast setting. If the multicast setting is enabled on the wireless LAN router/access point, disable it.

Cannot play audio data normally.

- Shuffle Play is selected. Press SHUFFLE repeatedly until “Shuffle On” disappears.

Play does not start, or does not automatically change to the next track or file.

- Make sure that the audio file you are trying to play is in a format supported by this receiver (page 49).
- WMA files with DRM copyright protection cannot be played back. For how to check the copyright protection of a WMA file, see page 69.

The sound skips during playback.

- The bandwidth of your wireless LAN may be too low. Move the receiver and the wireless LAN router/access point closer to each other, without any obstacles in between them.
- When using your computer as a server, the computer may be running many applications. If anti-virus software is active on the computer, temporarily disable the software as it needs large amount of system resources.
- Depending on the network environment, it may not be possible to play tracks with more than one device operating at the same time. Turn off another device to enable the receiver to play tracks.

“Cannot play” appears.

- You cannot play any files other than audio files.
- Confirm that the server has been set correctly (page 61). Confirm that the receiver has been registered to the server and allows the music streaming from the server.
- Check to confirm whether the audio file on the server has been damaged or erased. Refer to the operating instructions supplied with the server.
- You cannot play the following tracks:
 - A track that violates playback restrictions.
 - A track with irregular copyright information.

- A track that you purchased at an online music store that does not allow home network streaming.
- A track in a format unsupported by the receiver (page 49).
- Confirm that the selected track has not been erased from the server. If the track has been erased, select another track.
- Make sure that the wireless LAN router/access point is turned on.
- Make sure that the server is turned on.
- The server may be unstable. Restart it.
- Confirm that the receiver and the server are connected to the wireless LAN router/access point correctly.

“No Track” appears.

- If there are no tracks or folders in the selected folder, you cannot extend the folder to display its contents.

Cannot play back a copyrighted WMA format track.

- For how to check the copyright protection of a WMA file, see page 69.

Cannot select a previously selected track.

- The track information may have been changed on the server. Reselect the server in the server list (page 66).

Devices on the home network cannot connect to the receiver.

- “Network Standby” may be set to “Off”. Turn on the receiver or set “Network Standby” to “On” in Network Settings menu (page 101).
- Confirm that the network is correctly set up. If it is not, the connection cannot be made (page 101).
- The device on the device list is set to “Not Allow” (page 68), or the device is not added to the device list (page 68).
- A maximum of 20 connectable devices has been set. Delete unnecessary devices on the device list, and then set “Auto Access” to “Allow” (page 68).

- Server operation of the receiver is suspended if the receiver is conducting one of the following operations.
 - Playing a track stored on the server (the receiver is operating as a player)
 - Updating the software
 - Formatting the system

The receiver cannot be turned on automatically when accessed by devices on the network.

- The receiver itself does not support the Wake-on-LAN standard. Therefore the receiver cannot be turned on by Wake-on-LAN when “Network Standby” is set to “Off” in Network Settings menu. Set “Network Standby” to “On” so that the receiver can respond to operations by other devices via a network (page 101).

Devices on the network cannot turn on the receiver.

- The receiver cannot be turned on with a Wake-on-LAN start up operated by other devices on a network.

The receiver cannot play the track that is currently being played by the PARTY host.

- The PARTY host is playing a track of an audio format that cannot be played on the receiver.
- It may take a while before the playback sound is output.

The receiver joins an unintended PARTY.

- If more than one PARTY has been started when the receiver joins, the receiver may not be able to join the PARTY you want. Close the other PARTY, and then join the PARTY you want.
-

AirPlay

The receiver cannot be found from an iOS device.

- Check your set-up of the firewall of the security software. Refer to the website (page 127) for details.
- Make sure the iOS device or the computer with iTunes is connected to your home network.
- Update the AirPlay software version of the receiver and the iOS device to the latest version (page 73).

The sound skips.

- The sound may skip depending on factors such as the network environment when you use a wireless network.
- The servers are overloaded. Close all unneeded applications you are currently using.

This receiver cannot be operated.

- Update the software version of the iOS device to the latest version (page 75).
- Update the software version of the receiver to the latest version (page 75).
- Make sure another device is not streaming to the AirPlay-compatible device at the same time.

Buttons such as +/-, , , , , SHUFFLE and REPEAT do not work.

- Make sure that the settings that allow iTunes to accept control from this receiver are active.
- The receiver is not selected as the remote speaker on the iOS device. Select the receiver as the network speaker.

SEN

Cannot connect the receiver to a service.

- Make sure that the wireless LAN router/access point is turned on.
- Check the network status. See “Connection Status” in “Information” in Network Settings menu. If “Not connected” appears, set up the network connection again (page 39).
- When the system is connected to the wireless network, move the receiver and the wireless LAN router/access point closer to each other.
- If your contract with your Internet provider limits Internet connection to one device at a time, this device will not be able to access the Internet when another device is already connected. Consult your carrier or service provider.

The sound skips.

- The bandwidth of your wireless LAN may be too low. Move the receiver and the wireless LAN router/access point closer to each other, without any obstacles between.

Bluetooth device

Pairing cannot be done.

- Move the *Bluetooth* device closer to the receiver.
- Pairing may not be possible if other *Bluetooth* devices are present around the receiver. In this case, turn off the other *Bluetooth* devices.
- Enter the same passkey that was entered at the *Bluetooth* device correctly (page 79).

Cannot make the *Bluetooth* connection.

- The *Bluetooth* device you attempted to connect does not support the A2DP profile, and cannot be connected with the receiver.
- Press **BLUETOOTH** on the receiver to connect to the last connected *Bluetooth* device.
- Turn on the *Bluetooth* function of the *Bluetooth* device.
- Establish a connection from the *Bluetooth* device.
- The pairing registration information has been erased. Perform the pairing operation again (page 78).
- While connected to a *Bluetooth* device, this receiver cannot be detected and a connection cannot be established from another *Bluetooth* device.
- Erase the pairing registration information of a *Bluetooth* device (page 80) and perform the pairing operation again.

The sound skips or fluctuates, or the connection is lost.

- The receiver and the *Bluetooth* device are too far apart.
- If there are obstacles between the receiver and your *Bluetooth* device, remove or avoid the obstacles.
- If there is equipment that generates electromagnetic radiation, such as a wireless LAN, other *Bluetooth* device, or a microwave oven nearby, move them away.

The sound of your *Bluetooth* device cannot be heard on this receiver.

- Turn up the volume on your *Bluetooth* device first, and then adjust the volume using \triangle + (or **MASTER VOLUME** on the receiver).

Severe hum or noise.

- If there are obstacles between the receiver and your *Bluetooth* device, remove or avoid the obstacles.
- If there is equipment that generates electromagnetic radiation, such as a wireless LAN, other *Bluetooth* device, or a microwave oven nearby, move them away.
- Turn down the volume of the connected *Bluetooth* device.

“BRAVIA” Sync (Control for HDMI)

The Control for HDMI function does not work.

- Check the HDMI connection (page 31, 32).
- Make sure “Control for HDMI” is set to “On” in HDMI Settings menu (page 99).
- Make sure the connected equipment is compatible with the Control for HDMI function.
- Check the Control for HDMI settings on the connected equipment. Refer to the operating instructions of the connected equipment.
- If you unplug the HDMI cable or change the connection, repeat the procedures of “Preparing for the “BRAVIA” Sync” (page 82).
- When “Control for HDMI” is set to “Off”, the “BRAVIA” Sync does not work properly, even if the equipment is connected to the HDMI IN jack.
- The types and the number of equipment which can be controlled by the “BRAVIA” Sync feature are restricted in the HDMI CEC standard as follows.
 - Recording equipment (Blu-ray Disc recorder, DVD recorder, etc.): up to 3 equipment

- Playback equipment (Blu-ray Disc player, DVD player, etc.): up to 3 equipment
- Tuner-related equipment: up to 4 equipment (The receiver uses one of them for its GUI operations.)
- AV receiver (audio system): up to 1 equipment

The MHL-compatible source device cannot be charged.

- Check that the receiver is turned on.
- Make sure the device is connected firmly.

No image from MHL-compatible source device.

- Check the setting of your device. For details, refer to the operating instructions of your device.
 - Check that device is connected via a MHL cable to the HDMI/MHL (VIDEO 2) IN jack (page 32).
-

Remote control

The remote control does not function.

- Point the remote control at the remote control sensor on the receiver (page 10).
 - Remove any obstacles in the path between the remote control and the receiver.
 - Replace all the batteries in the remote control with new ones, if they are weak.
 - Make sure you select the correct input on the remote control.
 - When you operate a programmed non-Sony equipment, the remote control may not function properly depending on the model and the manufacturer of the equipment.
-

Error messages

If there is a malfunction, a message appears on the display panel. You can check the condition of the system by the message. If any problem persists, consult your nearest Sony dealer.

PROTECTOR

The receiver will automatically turn off after a few seconds, check the followings:

- There may be electrical surge or power failure. Unplug the AC power cord (mains lead), and then plug in the cord again after 30 minutes.
- The receiver is covered and ventilation holes are blocked. Remove the object covering the ventilation holes of the receiver.
- The impedance of the connected speakers is below the rated impedance range indicated on the back panel of the receiver. Reduce the volume level.
- Unplug the AC power cord (mains lead), let the receiver cool down for 30 minutes while troubleshooting the followings:
 - Disconnect all the speakers and subwoofer.
 - Check that the speaker wires are tightly twisted on both ends.
 - Connect front speaker first, increase the volume level and operate the receiver at least 30 minutes until it completely warms up. Then, connect each additional speaker one by one and test each additional speaker until you detect which speaker that is causing the protection error.

After checking above items and fixing any problems, plug in the AC power cord (mains lead) and turn on the receiver. If the problem persists, consult your nearest Sony dealer.

USB FAIL

An over current from the Ψ (USB) port was detected. The receiver will automatically turn off after a few seconds. Check the iPod/iPhone or USB device, then unplug it and turn on the power again.

For other messages, see “Message list after Auto Calibration measurement” (page 94), “iPod/iPhone message list” (page 49), “USB message list” (page 51) and “Network features message list” (page 76).

Clearing the memory

Reference sections

To clear	See
All memorized settings	page 90
Customized sound fields	page 60

About support information

Refer to the following web site for details of the latest information on the receiver.

For customers in the USA:

<http://www.esupport.sony.com/>

For customers in Canada:

[English]

<http://www.sony.ca/ElectronicsSupport/>

[French]

<http://fr.sony.ca/ElectronicsSupport/>

For customers in Latin America:

<http://esupport.sony.com/LA>

For customers in Brazil:

<http://esupport.sony.com/BR>

Specifications

AUDIO POWER SPECIFICATIONS

POWER OUTPUT AND TOTAL HARMONIC DISTORTION: (USA model only)

With 6 ohm loads, both channels driven, from 20 – 20,000 Hz; rated 100 watts per channel minimum RMS power, with no more than 0.09% total harmonic distortion from 250 milliwatts to rated output.

Amplifier section

USA and Canada models¹⁾

Minimum RMS Output Power
(6 ohms, 20 Hz – 20 kHz, THD 0.09%)
100 W + 100 W

Stereo Mode Output Power
(6 ohms, 1 kHz, THD 1%)
120 W + 120 W

Surround Mode Output Power²⁾
(6 ohms, 1 kHz, THD 0.9%)
165 W per channel

Mexico model¹⁾

Minimum RMS Output Power
(6 ohms, 20 Hz – 20 kHz, THD 0.09%)
95 W + 95 W

Stereo Mode Output Power
(6 ohms, 1 kHz, THD 1%)
110 W + 110 W

Surround Mode Output Power²⁾
(6 ohms, 1 kHz, THD 0.9%)
145 W per channel

Brazil model¹⁾

Surround Mode Output Power²⁾
(6 ohms, 1 kHz, THD 10%)
165 W per channel

¹⁾ Measured under the following conditions:

Area	Power requirements
USA, Canada	120 V AC, 60 Hz
Mexico	127 V AC, 60 Hz
Brazil	220 V AC, 60 Hz

²⁾ Reference power output for front, center, surround, surround back and front high speakers. Depending on the sound field settings and the source, there may be no sound output.

Frequency response

Analog

10 Hz – 100 kHz, +0.5/-2 dB (with sound field and equalizer bypassed)

Input

Analog

Sensitivity: 500 mV/50 kilohms
S/N³⁾: 105 dB (A, 500 mV⁴⁾)

Digital (Coaxial)

Impedance: 75 ohms
S/N: 100 dB (A, 20 kHz LPF)

Digital (Optical)

S/N: 100 dB (A, 20 kHz LPF)

Output (Analog)

ZONE 2

Voltage: 500 mV/1 kilohm

SUBWOOFER

Voltage: 2 V/1 kilohm

Equalizer

Gain levels

±10 dB, 1 dB step

³⁾ INPUT SHORT (with sound field and equalizer bypassed).

⁴⁾ Weighted network, input level.

FM tuner section

Tuning range

87.5 MHz – 108.0 MHz

Antenna (aerial)

FM wire antenna (aerial)

Antenna (aerial) terminals

75 ohms, unbalanced

AM tuner section

Tuning range

Area	Tuning scale	
	10 kHz step	9 kHz step
USA, Canada,	530 kHz –	531 kHz –
Mexico, Brazil	1,710 kHz	1,710 kHz

Antenna (aerial)

Loop antenna (aerial)

Video section

Inputs/Outputs

Video:

1 V_{p-p}, 75 ohms

COMPONENT VIDEO:

Y: 1 V_{p-p}, 75 ohms

PB: 0.7 V_{p-p}, 75 ohms

Pr: 0.7 V_{p-p}, 75 ohms

80 MHz HD Pass Through

HDMI Video

Input/Output (HDMI Repeater block)

Format	2D	3D		
		Frame packing	Side-by-Side (Half)	Over-Under (Top-and-Bottom)
4096 × 2160p @ 23.98/24 Hz	○	–	–	–
3840 × 2160p @ 29.97/30 Hz	○	–	–	–
3840 × 2160p @ 25 Hz	○	–	–	–
3840 × 2160p @ 23.98/24 Hz	○	–	–	–
1920 × 1080p @ 59.94/60 Hz	○	–	○	○
1920 × 1080p @ 50 Hz	○	–	○	○
1920 × 1080p @ 29.97/30 Hz	○*	○	○*	○*
1920 × 1080p @ 25 Hz	○*	○	○*	○*
1920 × 1080p @ 23.98/24 Hz	○*	○	○*	○*
1920 × 1080i @ 59.94/60 Hz	○*	○	○*	○*
1920 × 1080i @ 50 Hz	○*	○	○*	○*
1280 × 720p @ 59.94/60 Hz	○*	○	○*	○*
1280 × 720p @ 50 Hz	○*	○	○*	○*
1280 × 720p @ 29.97/30 Hz	○*	○	○*	○*
1280 × 720p @ 23.98/24 Hz	○*	○	○*	○*
720 × 480p @ 59.94/60 Hz	○*	–	–	–
720 × 576p @ 50 Hz	○*	–	–	–
640 × 480p @ 59.94/60 Hz	○*	–	–	–

* These formats are supported by MHL when you connect a MHL-compatible source device to the HDMI/MHL (VIDEO 2 IN) jack.

MHL section

Supported MHL version

Incorporates MHL 2

Maximum current

900 mA

iPod/iPhone section

DC 5V 1.0 A MAX

USB section

Supported format*

MP3 (MPEG 1 Audio Layer-3):

32 kbps – 320 kbps, VBR

AAC:

16 kbps – 320 kbps, CBR, VBR

WMA9 Standard:

40 kbps – 320 kbps, CBR, VBR

WAV:

8 kHz – 192 kHz, 16 bit PCM

8 kHz – 192 kHz, 24 bit PCM

FLAC:

8 kHz – 192 kHz, 16 bit FLAC

44.1 kHz – 192 kHz, 24 bit FLAC

* Compatibility with all encoding/writing software, recording devices and recording media cannot be guaranteed.

Transfer speed

High-speed

Supported USB device

Mass Storage Class

Maximum current

500 mA

NETWORK section

Ethernet LAN

10BASE-T/100BASE-TX

Wireless LAN

Compatible standards:

IEEE 802.11 b/g

Security:

WEP 64 bit, WEP 128 bit, WPA/
WPA2-PSK (AES), WPA/WPA2-
PSK (TKIP)

Radio frequency:

2.4 GHz

Bluetooth section

Communication system

Bluetooth Specification version 3.0

Output

Bluetooth Specification Power Class 2

Maximum communication range

Line of sight approx. 10 m¹⁾

Frequency band

2.4 GHz band (2.4000 GHz –
2.4835 GHz)

Modulation method

FHSS (Freq Hopping Spread Spectrum)

Compatible Bluetooth profiles²⁾

A2DP (Advanced Audio Distribution
Profile)

AVRCP 1.3 (Audio Video Remote
Control Profile)

Supported Codecs³⁾

SBC⁴⁾, AAC

Transmission range (A2DP)

20 Hz – 20,000 Hz (Sampling frequency
44.1 kHz)

¹⁾The actual range will vary depending on factors such as obstacles between devices, magnetic fields around a microwave oven, static electricity, cordless phone, reception sensitivity, antenna's performance, operating system, software application, etc.

²⁾Bluetooth standard profiles indicate the purpose of Bluetooth communication between devices.

³⁾Codec: Audio signal compression and conversion format

⁴⁾Subband Codec

General

Power requirements

Area	Power requirements
USA, Canada	120 V AC, 60 Hz
Mexico	127 V AC, 60 Hz
Brazil	127/220 V AC, 60 Hz

Power consumption

240 W

Power consumption (during standby mode)

0.3 W (When "Control for HDMI", "Pass Through", "Network Standby", and "Bluetooth Standby" are set to "Off", and the receiver in zone 2 is turned off.)

Dimensions (width/height/depth) (Approx.)

430 mm × 172 mm × 329.4 mm
(17 in × 6 7/8 in × 13 in) including
projecting parts and controls

Mass (Approx.)

10.0 kg (22 lb 1 oz)

Design and specifications are subject to change without notice.

Index

Numerics

- 2 channel 55
- 4K Scaling 99
- 5.1 channel 24
- 7.1 channel 24

A

- A/V Sync 98, 106
- Access Point Scan 40
- Advanced Auto Volume 98
- AirPlay 73
- Alphabet search 17
- AM 52
- Audio Out 99, 106
- Audio Settings 97, 106
- Auto Calibration Settings 103
- Auto Calibration Type 103
- Auto Phase Matching 95
- Auto Standby 102, 107
- Auto Tuning 52

B

- Bass 58, 105
- Bi-amplifier Connection 87
- Bluetooth AAC 81, 106
- Bluetooth* Settings 106
- Blu-ray Disc player 31
- BRAVIA Sync
 - preparing 82

C

- Cable TV tuner 31
- CD player 31
- Center Speaker Lift Up 97

Clear

- memory 90
- remote control 112
- sound field 60

Connection

- antennas 34
 - iPod/iPhone 34
 - MHL Device 32
 - Network 35
 - speakers 26
 - TV 28
 - USB device 34
 - Wired 36
 - Wireless 36
- Control for HDMI 99, 106
 - Crossover frequency 96, 105

D

- DCAC (Digital Cinema Auto Calibration) 38
- Device Name 101
- Digital Legato Linear (D.L.L.) 97, 106
- Direct Tuning 53
- Display panel 12
- Distance Unit 97, 105
- DLNA 60
- Dolby Digital EX 23
- Dual Mono 98, 106
- DVD player 31
- DVD recorder 31
- Dynamic range compressor 99, 106

E

- Easy Setup 37
- Effect level 55, 105
- EQ Settings 58, 105

F

Fast View 100
Fixed IP address 41
FM 52
FM Mode 52, 106

G

GUI (Graphical User Interface) 43

H

HD-D.C.S. 55
HDMI 106
HDMI Settings 99, 106
HDMI Subwoofer Level 100, 106
Home Network 66
Home Theatre Control 84

I

Input 45
Input Assign 86
INPUT MODE 86
Input Settings 100, 105
IP Setting 101
iPod/iPhone 34
 Charging 48
 Compatible models 47

L

Language 102
Level Settings 103
Listen 45

M

Menu 90, 103
Message
 Auto Calibration 94
 Error 126
 iPod/iPhone 49
 Network features 76
 USB 51
MHL 32
Movie mode 55
Multi zone 88
Music mode 56
Music Services 70
Muting 46

N

Name Input 54
Network Settings 101
Network Standby 101
Network Update 102

O

One-Touch Play 83

P

PARTY STREAMING 72
Pass Through 99, 106
Passkey 79
PlayStation 3 31
Preset Memory 54
Preset stations 54
PROTECTOR 126
Pure Direct 59

R

Remote control 15, 108
Remote Easy Control 84
Resetting 90

S

Satellite tuner 31
Scene Select 84
SEN 70
Server 61
Server list 66
Settings menu 90
Sleep Timer 16
Software Update Notification 102
Software Version 102
Sound Effects 55
Sound field 55
Speaker Connection 95
Speaker Pattern 95, 104
Speaker Settings 93, 104
Super Audio CD player 31
Surround Settings 105
System Audio Control 83
System Power-Off 83
System Settings 102, 107

T

Test Tone 97, 103
Treble 58, 105
Tuner 52
Tuner Settings 106
TV 28
TV SideView 68

U

Up converting 22
USB device 34, 49
USB FAIL 127

V

VCR 31
Viewing information on the display
panel 107

W

Wake-on-LAN 67
Watch 45
Wired network 43
Wireless LAN antenna 14
Wireless LAN signal strength 13
Wireless network 39
WPS
 PIN code 42
 Push button 42

Z

Zone 2 88

END-USER LICENSE AGREEMENT FOR SONY SOFTWARE

You should carefully read the following agreement before using the SONY SOFTWARE (defined below). Using the SONY SOFTWARE indicates your acceptance of the agreement. If you do not agree with it, you are not authorized to use the SONY SOFTWARE.

IMPORTANT - READ CAREFULLY: This End-User License Agreement (“EULA”) is a legal agreement between you and Sony Corporation (“SONY”), the manufacturer of your Sony hardware device (the “PRODUCT”) and the licensor of the SONY SOFTWARE. All Sony software and third party software (other than such software subject to its own separate license) included with your PRODUCT and any updates and upgrades thereto shall be referred to herein as the “SONY SOFTWARE”. You may use the SONY SOFTWARE only with the PRODUCT.

By using the SONY SOFTWARE, you agree to be bound by the terms of this EULA. If you do not agree to the terms of this EULA, SONY is unwilling to license the SONY SOFTWARE to you. In such event, you should not use the SONY SOFTWARE.

SONY SOFTWARE LICENSE

The SONY SOFTWARE is protected by copyright laws and international copyright treaties, as well as other intellectual property laws and treaties. The SONY SOFTWARE is licensed, not sold.

GRANT OF LICENSE

All title, copyright and other rights in and to the SONY SOFTWARE are owned by SONY or its licensors. This EULA grants you the right to use the SONY SOFTWARE for personal use only.

DESCRIPTION OF REQUIREMENTS, RESTRICTIONS, RIGHTS AND LIMITATIONS

Limitations. You may not copy, modify, reverse engineer, decompile or disassemble the SONY SOFTWARE in whole or in part.

Separation of Components. The SONY SOFTWARE is licensed as a single product. Its component parts may not be separated.

Use on Single PRODUCT. The SONY SOFTWARE may only be used with a single PRODUCT.

Rental. You may not rent or lease the SONY SOFTWARE.

Software Transfer. You may permanently transfer all of your rights under this EULA only when the SONY SOFTWARE is transferred together with and as part of the PRODUCT, provided that you retain no copies, transfer all of the SONY SOFTWARE (including but not limited to all copies, component parts, media, instruction manuals, other printed materials, electronic documents, recovery disks and this EULA) and the recipient agrees to the terms of this EULA.

Termination. Without prejudice to any other rights, SONY may terminate this EULA if you fail to comply with the terms of this EULA. In such event, when requested by SONY, you must send the PRODUCT to an address designated by SONY, and SONY will send back the PRODUCT to you as soon as practicable after the SONY SOFTWARE has been deleted from the PRODUCT.

Confidentiality. You agree to keep confidential information contained in SONY SOFTWARE which is not publicly known and not to disclose such information to others without SONY’s prior written approval.

HIGH RISK ACTIVITIES

The SONY SOFTWARE is not fault-tolerant and is not designed, manufactured or intended for use or resale as on-line control equipment in hazardous environments requiring fail-safe performance, such as in the operation of nuclear facilities, aircraft navigation or communication systems, air traffic control, direct life support machines or weapons systems, in which the failure of the SONY SOFTWARE could lead to death, personal injury or severe physical or environmental damage (“High Risk Activities”). SONY and its suppliers specifically disclaim any express or implied warranty of fitness for High Risk Activities.

EXCLUSION OF WARRANTY ON SONY SOFTWARE

You expressly acknowledge and agree that use of the SONY SOFTWARE is at your sole risk. The SONY SOFTWARE is provided "AS IS" and without warranty of any kind, and SONY, its vendors and SONY's licensors (for purposes of this SECTION only, collectively, "SONY") EXPRESSLY DISCLAIM ALL WARRANTIES, EXPRESS OR IMPLIED, INCLUDING BUT NOT LIMITED TO THE IMPLIED WARRANTIES OF MERCHANTABILITY AND FITNESS FOR A PARTICULAR PURPOSE. SONY DOES NOT WARRANT THAT THE FUNCTIONS CONTAINED IN THE SONY SOFTWARE ARE FREE FROM ERRORS OR BUGS OR WILL MEET YOUR REQUIREMENT, AND SONY DOES NOT WARRANT THAT THE OPERATION OF THE SONY SOFTWARE WILL BE CORRECTED. FURTHERMORE, SONY DOES NOT WARRANT OR MAKE ANY REPRESENTATIONS REGARDING THE USE OR THE RESULTS OF THE USE OF THE SONY SOFTWARE IN TERMS OF ITS CORRECTNESS, ACCURACY, RELIABILITY OR OTHERWISE. NO ORAL OR WRITTEN INFORMATION OR ADVICE GIVEN BY SONY OR A SONY AUTHORIZED REPRESENTATIVE SHALL CREATE A WARRANTY OR IN ANY WAY INCREASE THE SCOPE OF THIS WARRANTY. SOME JURISDICTIONS DO NOT ALLOW THE EXCLUSION OF IMPLIED WARRANTIES, IN WHICH CASE THE ABOVE EXCLUSION WOULD NOT APPLY TO YOU.

Without limiting any of the foregoing, it is specifically provided that the SONY SOFTWARE is not designed or intended for use on any product other than the PRODUCT. SONY provides no warranty that any product, software, content or data created by you or a third party will not be damaged by the SONY SOFTWARE.

LIMITATION OF LIABILITY

SONY, ITS SUPPLIERS AND SONY'S LICENSOR'S (for purposes of this SECTION ONLY, collectively, "SONY") SHALL NOT BE LIABLE FOR ANY INCIDENTAL OR CONSEQUENTIAL DAMAGES RELATING TO THE SONY SOFTWARE ARISING FROM OR BASED ON BREACH OF ANY EXPRESS OR IMPLIED WARRANTY, BREACH OF CONTRACT, NEGLIGENCE, STRICT LIABILITY OR ANY OTHER LEGAL THEORY. SUCH DAMAGES INCLUDE, BUT ARE NOT LIMITED TO, LOSS OF PROFITS, LOSS OF REVENUE, LOSS OF DATA, LOSS OF USE OF THE PRODUCT OR ANY ASSOCIATED EQUIPMENT, DOWN TIME AND USER'S TIME, REGARDLESS OF WHETHER SONY HAS BEEN ADVISED OF THE POSSIBILITY OF SUCH DAMAGES. IN ANY CASE, SONY'S ENTIRE LIABILITY TO YOU UNDER ANY PROVISION OF THIS EULA SHALL BE LIMITED TO THE AMOUNT ACTUALLY PAID ALLOCABLE TO THE SONY SOFTWARE.

EXPORTS

If you use or transfer the SONY SOFTWARE in or to a country other than your country of residence, you shall comply with applicable laws and regulations relating to exports, imports and customs.

GOVERNING LAW

This EULA shall be construed, governed, interpreted and applied in accordance with the laws of Japan, without regards to any conflict of laws provisions. Any dispute arising out of this EULA shall be subject to the exclusive venue and jurisdiction of the courts in Tokyo, Japan, and you and SONY hereby consent to the venue and jurisdiction of such courts. YOU AND SONY WAIVE THE RIGHT TO TRIAL BY JURY WITH RESPECT TO ANY MATTERS ARISING UNDER OR RELATING TO THIS EULA.

SEVERABILITY

If any part of this EULA is held invalid or unenforceable, other parts will remain valid.

Should you have any questions in connection with this EULA or the limited warranty provided hereunder, you may contact SONY by writing to SONY at the designated contact address mentioned in the warranty card included in the product package.



<http://www.sony.net/>

4-454-443-11(1)



* 4 4 5 4 4 4 3 1 1 * (1)